

BAGGAGE COMPARTMENT FLOOR PROTECTOR, KIT INSTRUCTIONS FOR CONTINUING AIRWORTHINESS

MODELS: BELL 206A/B

Read all of the Instructions for Continuing Airworthiness
thoroughly prior to performing any activities relating to this product

Table of Contents

<u>Section</u>	<u>Description</u>	<u>Page</u>
1	Description	2
2	Maintenance Manual Supplement	3
3	Installation & Removal Instructions	7
	Installation Instructions	8
	Removal Instructions	11
4	Illustrated Parts Breakdown	12

Notes

1. If changes to this document are required, Alpine Aerotech LP shall revise all pages and reissue the entire document.
2. Alpine Aerotech LP shall make any subsequent revisions of this document available free of charge upon request. Alpine Aerotech LP also recommends that the end user of this product periodically verify the revision level of this document.
3. The data described in this document have been found conformant to specification AAL-005-014-006. This specification has been found to be acceptable by a delegate of the Minister of Transport in conformity with paragraph 4.2(o) and subsection 4.1(1) of the Aeronautics Act.

It is the responsibility of the installer to determine that the modification as installed in the aircraft does not constitute a major modification prior to use of this data.

Section 1: Description

Description

The following information provides a functional description of the Baggage Compartment Floor Protector, Kit as defined in Alpine Aerotech LP authority dataset AAL-313-050-001.

- Due to the fact that the Bell light series of aircraft is used as often for seismic, logging, and other industrial uses, there is a potential for cargo to damage expensive composite panels located in the baggage compartment. This occurs most frequently during loading and unloading operations, but can also occur during small inflight shifts of said cargo.
- The Baggage Compartment Floor Protector, Kit when installed adds additional protection to the panel, as it is manufactured from a material specifically designed to spread and attenuate energy.

Section 2: Maintenance Manual Supplement

General Notes

1. The following information defines the instructions for continuing airworthiness, repair allowances and airworthiness limitations for the item(s) referenced within this document.
2. Refer to the current revisions of the BHT Maintenance Manual BHT-206A/B-SERIES-MM for Instructions for Maintenance/Inspection with respect to the item(s) referenced within this document.
3. Refer to the Section 3: Installation & Removal Instructions and Section 4: Illustrated Parts Breakdown for the replacement and/or installation of the item(s) referenced within this section.
4. Scheduled inspection for the item(s) referenced within this document shall be accomplished in accordance with (IAW) the Inspection Procedures specified.
5. Repair allowances for the item(s) referenced within this document shall be accomplished IAW the Repair Procedures specified.
6. Limitations for the item(s) referenced within this document are IAW the Airworthiness Limitations specified.

Airworthiness Limitations

Supplement to applicable Maintenance Manual, Chapter 4, Airworthiness Limitations Schedule

Notes

1. Refer to the applicable Maintenance Manual, Chapter 4-1, for general information on airworthiness limitations and airworthiness limitation schedules.
2. Item(s) **not** listed in the Scheduled Airworthiness Limitations section within this document have an unlimited airworthiness life.

Scheduled Airworthiness Limitations

1. There are no airworthiness limitations associated with the item(s) referenced within this document.

Inspection Procedures

Supplement to applicable Maintenance Manual, Chapter 5, Inspection and Component Overhaul Schedule

Notes

1. Refer to the applicable Maintenance Manual, Chapters 4-1, for general information on inspections, inspection definitions, inspection intervals, inspection methods and inspection schedules.
2. Detailed Inspections, as indicated within this document, are defined as visual and thorough, searching checks.
3. Perform 300 Hour/12 Month Inspections every 300 hours or every 12 months, whichever occurs first, prior to flight operation. If damage is detected, refer to the Repair Procedures section within this document.

Scheduled Inspections

1. 300 Hour/12 Month Inspections

Data Reference: Section 3: Installation and Removal Instructions
Section 4: Illustrated Parts Breakdown

- I. Perform a Detailed Inspection on all items to ensure proper security.
- II. Perform a Detailed Inspection on all items/materials to ensure proper integrity.
- III. Perform a Detailed Inspection on the Baggage Compartment Floor Protector, Kit to ensure that it is not delaminating.
- IV. Perform a Detailed Inspection on all surfaces & locations with Velcro applied to ensure no damage has occurred to the underlying honeycomb panel.

Repair Procedures

1. Repairs to the item(s) referenced within this document are **not** permitted. Contact Alpine Aerotech LP for further information if repairs are required to the item(s) referenced within this document.

Section 3: Installation & Removal Instructions

Weight & Balance

<u>Part Number</u>	<u>Description</u>	<u>Weight</u>	<u>Long. Arm</u>	<u>Lat. Arm</u>
AAL-313-050-001	Baggage Compartment Floor Protector, Kit	3.17*	145.56	1.15RBL
		1.44 (Kg)	3.69 (m)	.029 (m)

* Total increase in weight to aircraft.

General Notes

1. All Installation Instructions shall be accomplished IAW standard aircraft practices. Refer to the current revision of the FAA manuals AC 43.13-1B and AC 43.13-2B for details on standard aircraft practices.
2. All Dimensions are in imperial measures (inches/pounds).
3. Refer to Section 2: Maintenance Manual Supplement for instructions on maintenance for the item(s) referenced within this section.
4. Refer to the Section 4: Illustrated Parts Breakdown for the part numbers of the item(s) referenced within this section.

Installation Notes

 Typical item number for all like items in this view unless otherwise specified.

Installation Instructions

1. Gain access to the baggage compartment floor. Reference Figure 1.

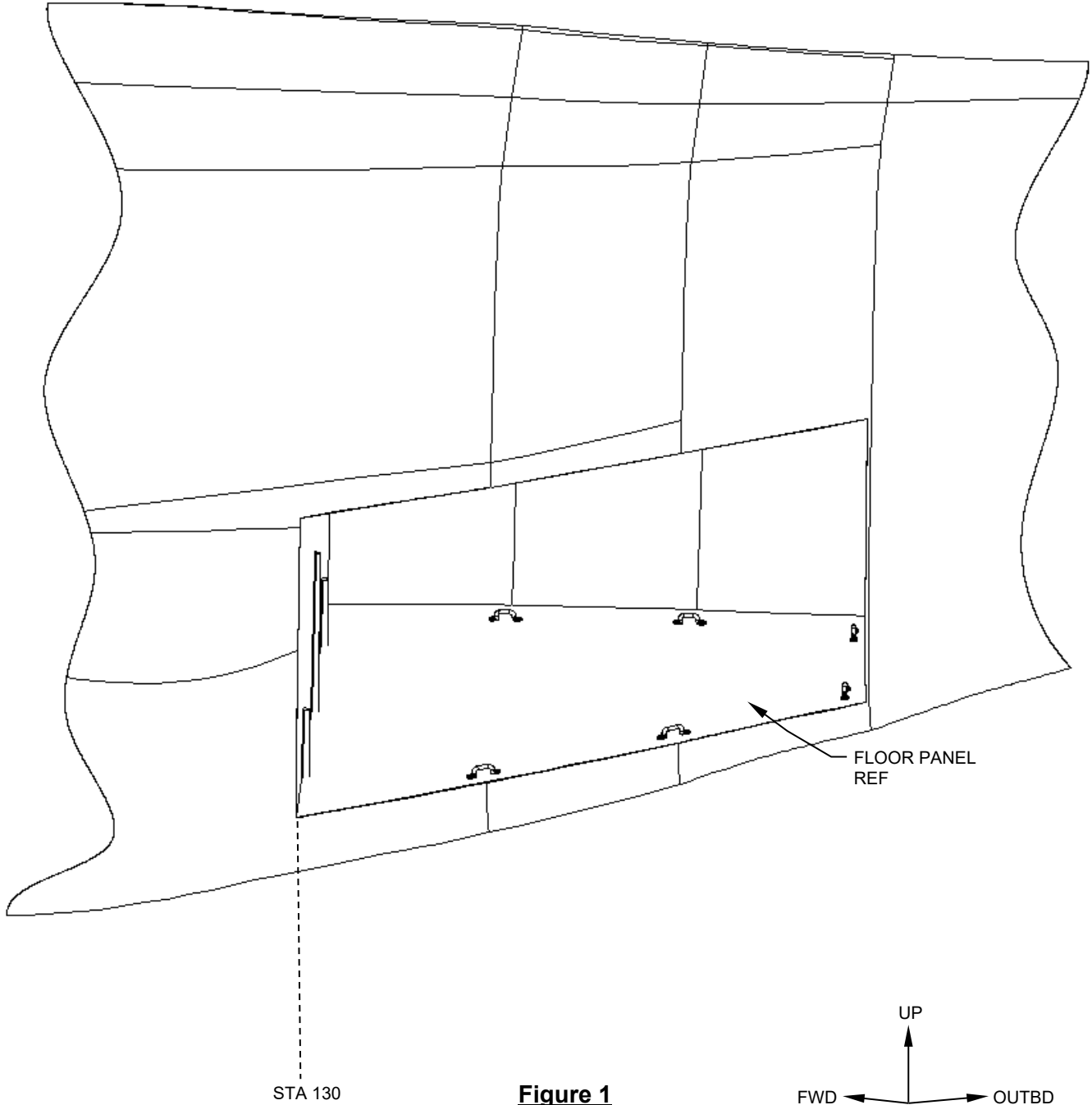

Figure 1
Some Items
Removed for
Clarity

Installation Instructions

2. Pre-fit the Panel, Assy (Item 1) by lining up the slots & oval cut outs with the footman loops & ribs mounted to the floor panel. Reference Figures 1 & 2.
3. With the panel lined up use the pre-cut .25 holes and a felt pen to mark out the locations for the Velcro, Details (Items 6, 7 & 8) and remove the panel (Item 1). Reference Figure 2.

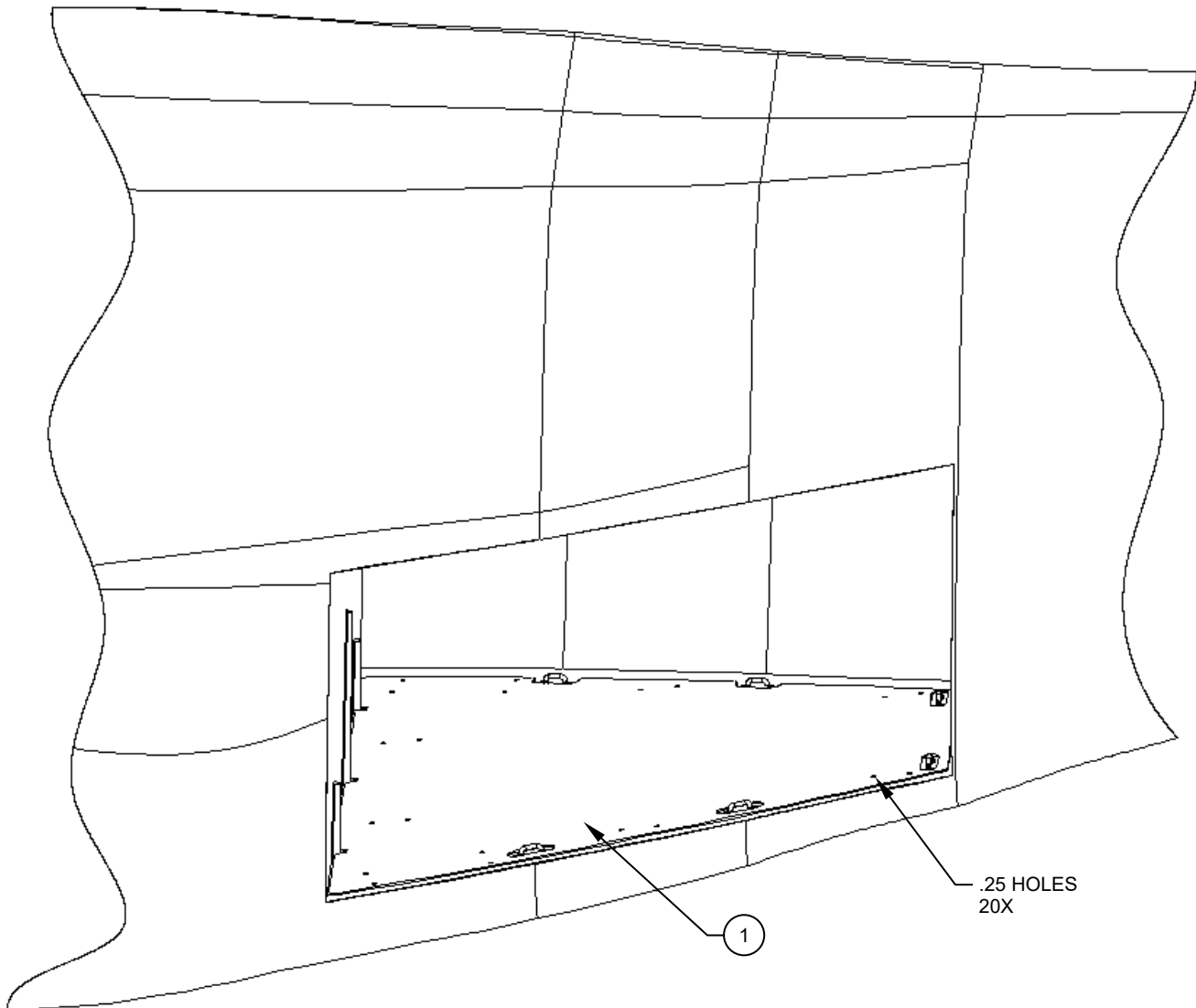
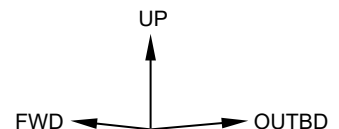
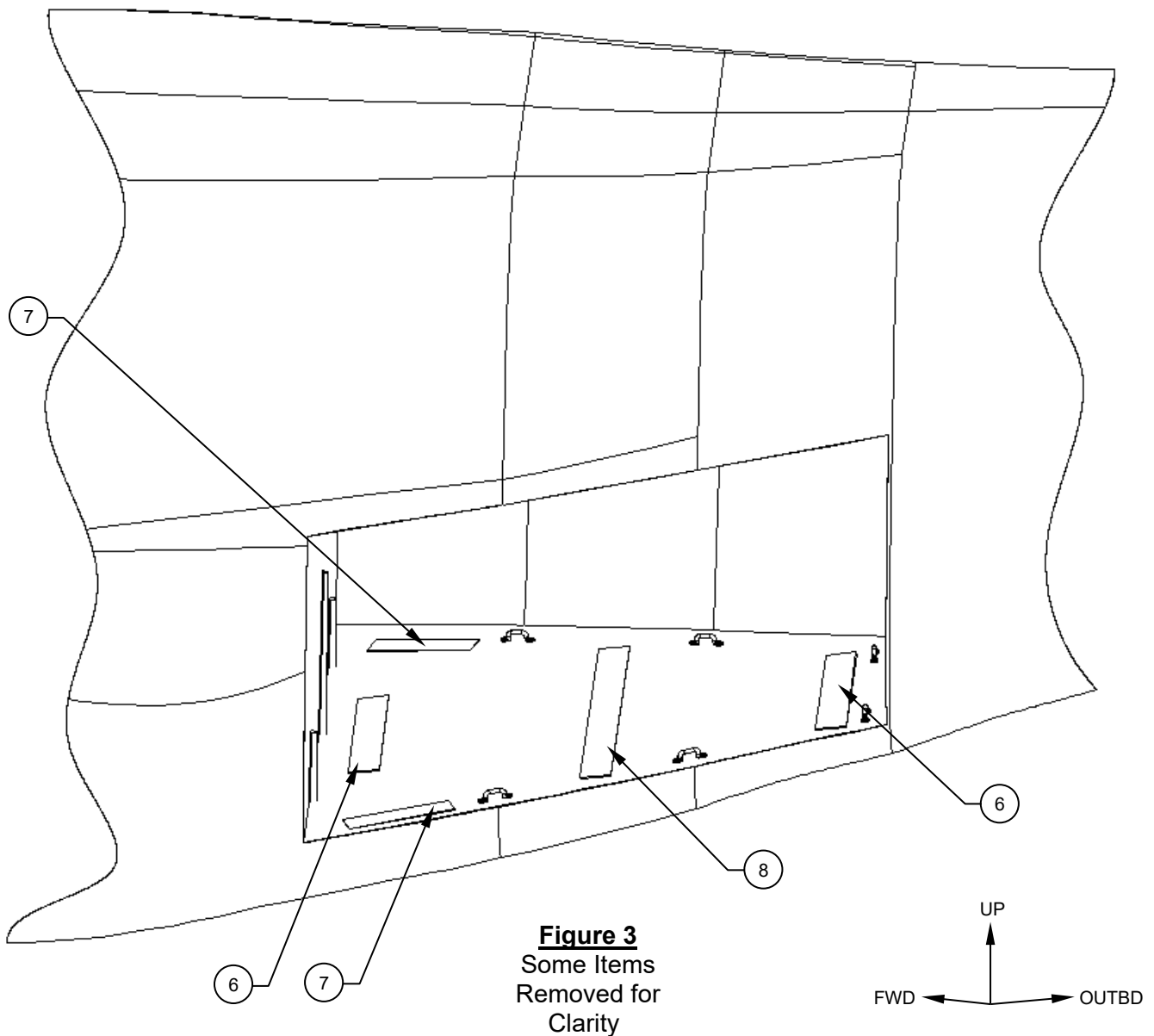

Figure 2
Some Items
Removed for
Clarity



Installation Instructions

4. Clean the areas between the felt pen marks with alcohol taking care not to wipe away the felt pen marks.
5. Individually separate each Velcro, Detail (Items 6, 7 & 8) off of the Floor Panel, Assy (Item 1) and peel adhesive backing from the Velcro, Details (Items 6, 7 & 8).
6. Using the felt pen marks as reference points, apply the Velcro, Details (Items 6, 7 & 8) to the honeycomb panel in their respective locations. Reference Figure 3. Apply adequate pressure to ensure a secure bond.



Installation Instructions

7. Re-install the Floor Panel, Assy (Item 1) onto Velcro strips.
8. Installation complete.
9. Perform a General Inspection of all items to ensure proper installation.
10. Update the aircraft logbook for the installation of the Baggage Compartment Floor Protector, Kit.

Removal Instructions

1. The removal of the Baggage Compartment Floor Protector, Kit for either inspections, or mission configuration, can be considered the opposite of installation for step 7. For permanent removal, of the Baggage Compartment Floor Protector, Kit perform step 7 opposite of installation and remove all bonded Velcro, Details.
2. Perform a General Inspection of all items to ensure proper removal.
3. Update the aircraft logbook for the removal of the Baggage Compartment Floor Protector, Kit.

Section 4: Illustrated Parts Breakdown

General Notes

1. Alternate items listed.

 Typical item number for all like items in this view unless otherwise specified.

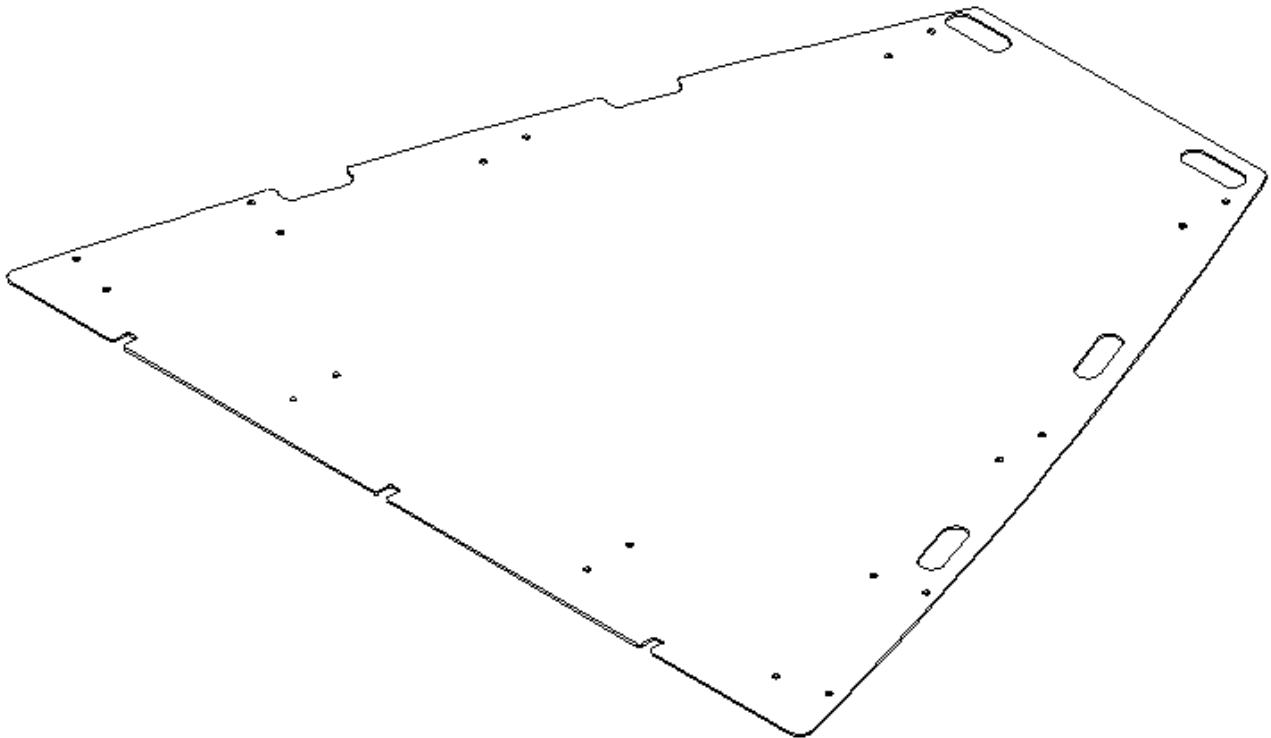

Panel, Assy
Shown
Item 1

Illustrated Parts Breakdown (Cont.)

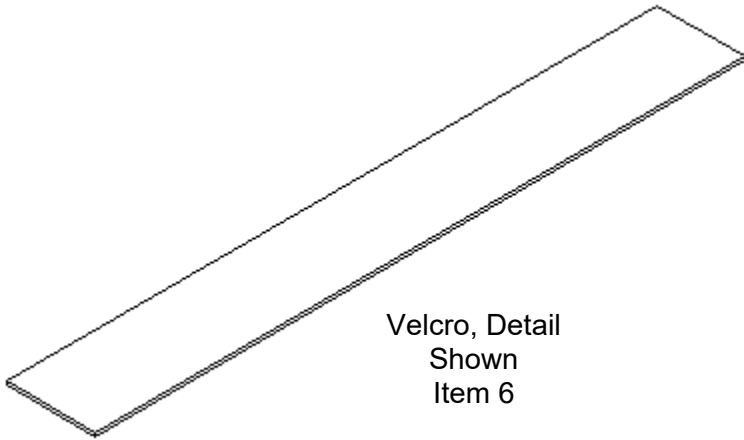

Velcro, Detail
Shown
Item 6

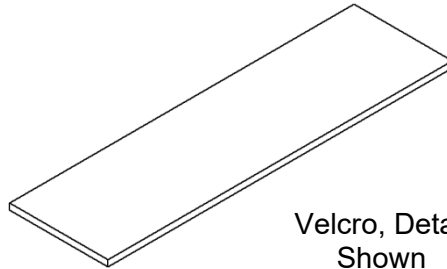

Velcro, Detail
Shown
Item 7

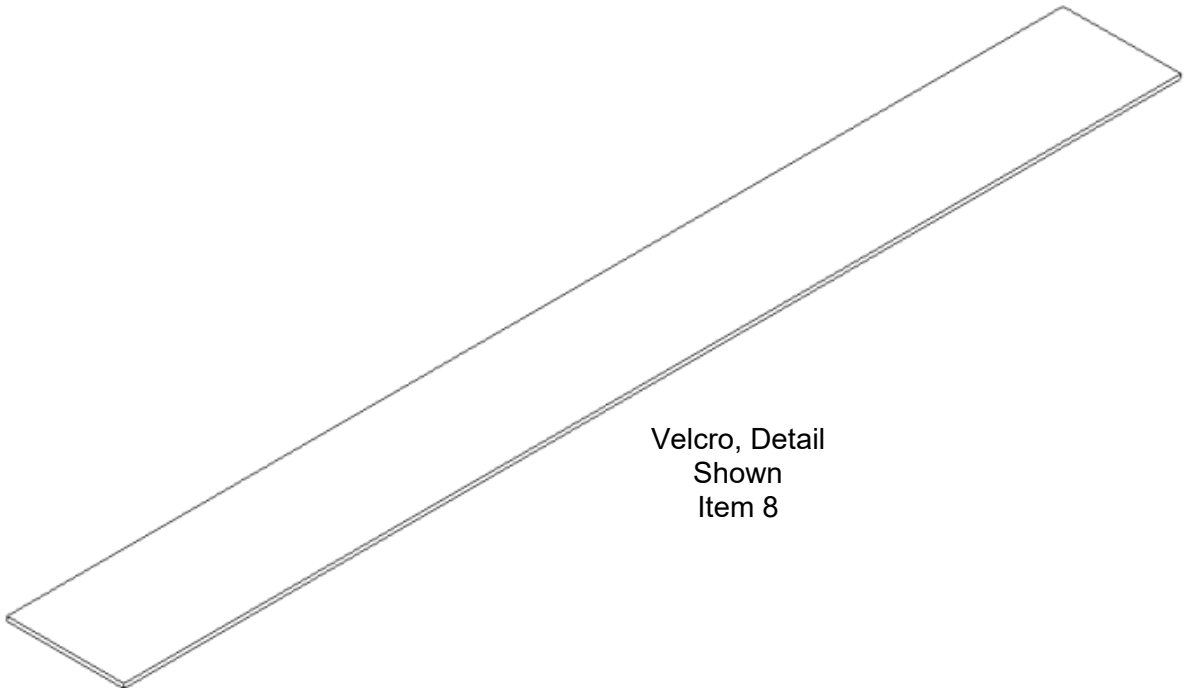

Velcro, Detail
Shown
Item 8

Illustrated Parts Breakdown (Cont.)

ITEM	QTY	NUMBER	DESCRIPTION	MATERIAL	REF STOCK SIZE	FINISH	SPEC	MANUFACTURER	NCAGEC
-	-	AAL-313-050-001	BAGGAGE COMPARTMENT FLOOR PANEL PROTECTOR, KIT	C/O SHADED ITEMS ONLY					
1	1	AAL-313-051-001	PANEL, ASSY	NA	NA	NA	NA	ALPINE AEROTECH LP	L0171
2	1	>AAL-313-052-001	PANEL, DETAIL	NA	0.1	SEE MFR	SEE MFR	ALPINE AEROTECH LP	L0171
3	2	>>151394	VELCRO, DETAIL	LOOP 1000, BLACK, 8224 PSA	2 X 14.75	SEE MFR	SEE MFR	VELCRO USA INC.	11153
4	1	>>151394	VELCRO, DETAIL	LOOP 1000, BLACK, 8224 PSA	2 X 26.00	SEE MFR	SEE MFR	VELCRO USA INC.	11153
5	2	>>151394	VELCRO, DETAIL	LOOP 1000, BLACK, 8224 PSA	2 X 7.00	SEE MFR	SEE MFR	VELCRO USA INC.	11153
6	2	151405	VELCRO, DETAIL	HOOK 88, BLACK 8289 PSA	2 X 14.75	SEE MFR	SEE MFR	VELCRO USA INC.	11153
7	2	151405	VELCRO, DETAIL	HOOK 88, BLACK 8289 PSA	2 X 7.00	SEE MFR	SEE MFR	VELCRO USA INC.	11153
8	1	151405	VELCRO, DETAIL	HOOK 88, BLACK 8289 PSA	2 X 26.00	SEE MFR	SEE MFR	VELCRO USA INC.	11153