

RHS SLIDING DOOR, LONG LINE FLOOR PROTECTION, KIT INSTRUCTIONS FOR CONTINUING AIRWORTHINESS

MODELS: EUROCOPTER AS350*

*With AFT RHS sliding doors and long line window installed

Read all of the Instructions for Continuing Airworthiness thoroughly prior to performing any activities relating to this product



Table of Contents

<u>Section</u>	<u>Description</u>	<u>Page</u>
1	Description	2
2	Maintenance Manual Supplement	3
3	Installation & Removal Instructions	8
	Installation Instructions	9
	Removal Instructions	16
4	Illustrated Parts Breakdown	17

Notes

1. If changes to this document are required, Alpine Aerotech LP shall revise all pages and reissue the entire document.
2. Alpine Aerotech LP shall make any subsequent revisions of this document available free of charge upon request. Alpine Aerotech LP also recommends that the end user of this product periodically verify the revision level of this document.

Section 1: Description

Description

The following information provides a functional description of the RHS Sliding Door, Long Line Floor Protection, Kit as defined in Alpine Aerotech LP authority dataset AAL-312-020-008.

- The Floor Boards are rigid pieces of material that are installed atop the existing floor to protect it from dents and punctures associated with typical aircraft usage. This occurs most frequently during loading and unloading operations, but can also occur during small inflight shifts of said cargo.
- The RHS Sliding Door, Long Line Floor Protection, Kit when installed, adds additional protection to the floor panels, as it is manufactured from a material specifically designed to spread and attenuate energy.



Section 2: Maintenance Manual Supplement

General Notes

1. The following information defines the instructions for continuing airworthiness, repair allowances and airworthiness limitations for the item(s) referenced within this document.
2. Refer to the current revisions of the Eurocopter AS350 Master Service Manual for Instructions for Maintenance/Inspection with respect to the item(s) referenced within this document.
3. Refer to the Section 3: Installation & Removal Instructions and Section 4: Illustrated Parts Breakdown for the replacement and/or installation of the item(s) referenced within this section.
4. Scheduled inspection for the item(s) referenced within this document shall be accomplished in accordance with (IAW) the Inspection Procedures specified.
5. Repair allowances for the item(s) referenced within this document shall be accomplished IAW the Repair Procedures specified.
6. Limitations for the item(s) referenced within this document are IAW the Airworthiness Limitations specified.



Airworthiness Limitations

The Airworthiness Limitations section is approved by the Minister and specifies maintenance required by any applicable airworthiness or operating rule unless an alternative program has been approved by the Minister.

The Airworthiness Limitations section is FAA approved and specifies maintenance required under Sections 43.16 and 91.403 of the Federal Aviation Regulations unless an alternative program has been FAA approved.

Supplement to applicable Maintenance Manual, Chapter 4, Airworthiness Limitations Schedule

Notes

1. Refer to the applicable Master Service Manual, Chapters for general information on airworthiness limitations and airworthiness limitation schedules.
2. Item(s) **not** listed in the Scheduled Airworthiness Limitations section within this document have an unlimited airworthiness life.

Scheduled Airworthiness Limitations

1. There are no airworthiness limitations associated with the item(s) referenced within this document.



Inspection Procedures

Supplement to applicable Maintenance Manual, Chapter 5, Inspection and Component Overhaul Schedule

Notes

1. Refer to the applicable Master Service Manual, Breakdown of the MSM Section 7, for general information on inspections, inspection definitions, inspection intervals, inspection methods and inspection schedules.
2. General Inspections, as indicated within this document, are defined as visual, non-thorough checks.
3. Detailed Inspections, as indicated within this document, are defined as visual and thorough, searching checks.
4. Perform Daily Inspections every day, prior to flight operation. If damage is detected, perform the 150 Hour/12 Month Inspections.
5. Perform 150 Hour/12 Month Inspections every 150 hours or every 12 months, whichever occurs first, prior to flight operation. If damage is detected, refer to the Repair Procedures section within this document.

Scheduled Inspections

1. Daily Inspections

Data Reference: Section 3: Installation and Removal Instructions
Section 4: Illustrated Parts Breakdown

- i. Perform a General Inspection on the RHS Sliding Door, Long Line Floor Protection, Kit , Installation for general condition.
- ii. Perform a General Inspection on the RHS Sliding Door, Long Line Floor Protection, Kit , Installation for proper security.



Scheduled Inspections

2. 150 Hour/12 Month Inspections

Data Reference: Section 3: Installation and Removal Instructions
Section 4: Illustrated Parts Breakdown

- I. Perform a Detailed Inspection on all items to ensure proper security.
- II. Perform a Detailed Inspection on all items/materials to ensure proper integrity.
- III. Perform a Detailed Inspection on the RHS Sliding Door, Long Line Floor Protection, Kit to ensure that it is not delaminating.
- IV. Perform a Detailed Inspection on all surfaces & locations with Velcro applied to ensure no damage has occurred to the aircraft floor.



Repair Procedures

1. Repairs to the item(s) referenced within this document are **not** permitted. Contact Alpine Aerotech LP for further information if repairs are required to the item(s) referenced within this document.



Section 3: Installation & Removal Instructions

Weight & Balance

<u>Part Number</u>	<u>Description</u>	<u>Weight</u>	<u>Long. Arm</u>	<u>Lat. Arm</u>
AAL-312-020-008	RHS Sliding Door, Long Line Floor Protection, Kit	13.00*	69.476	1.911 LBL
		5.896 (Kg)	1.765 (m)	.048(m)

* Total increase in weight to aircraft.

General Notes

1. All Installation Instructions shall be accomplished IAW standard aircraft practices. Refer to the current revision of the FAA publications AC 43.13-1B and AC 43.13-2B for details on standard aircraft practices.
2. All Dimensions are in imperial measures (inches/pounds).
3. Refer to Section 2: Maintenance Manual Supplement for instructions on maintenance for the item(s) referenced within this section.
4. Refer to the Section 4: Illustrated Parts Breakdown for the part numbers of the item(s) referenced within this section.



Alternate Part: DIN965-M4 x 16



Alternate Part: DIN7985-M4 x 18



Installation Instructions

1. Gain access to the cabin floor, temporarily remove all seats, LHS collective, & foot pedals. Remove any existing floor board protection kits, door sills, sliding door transition sill and all related fasteners. Reference Figure 1.

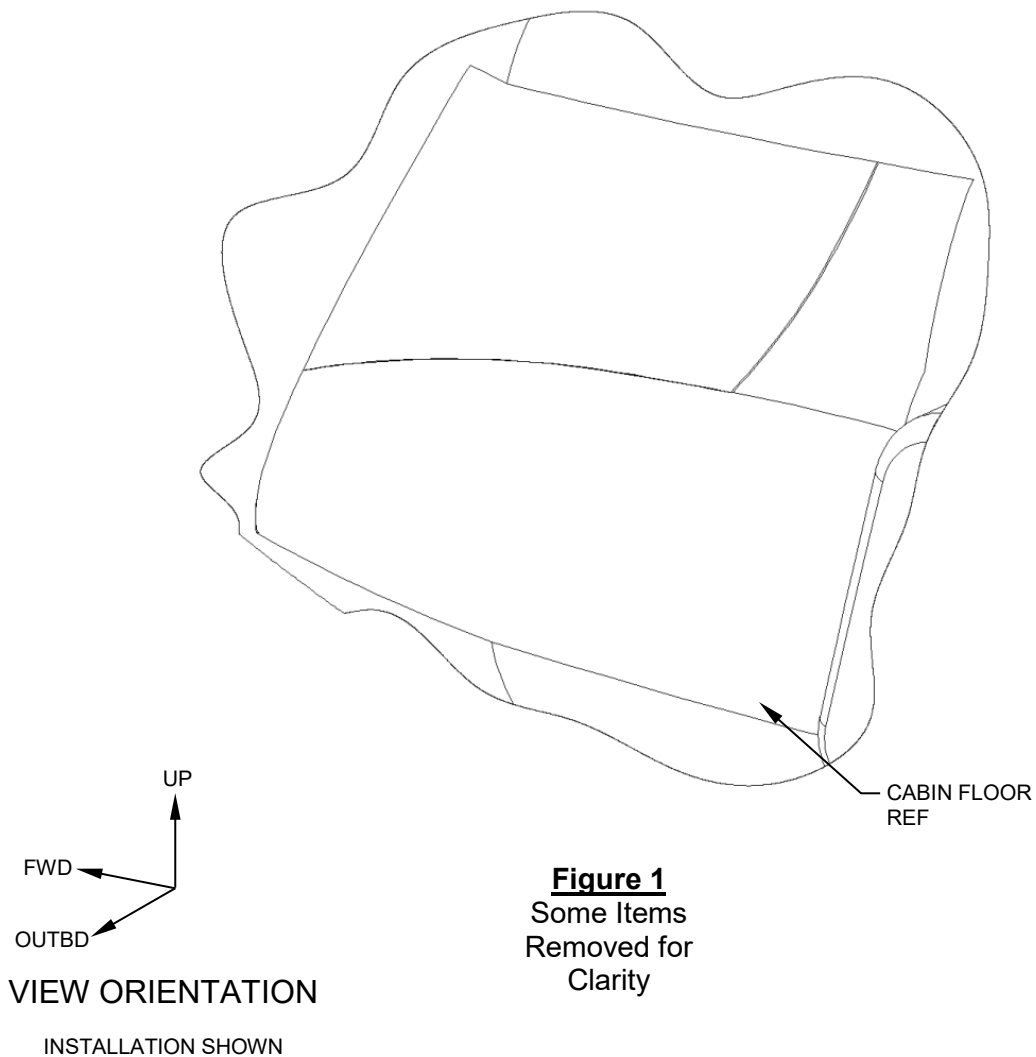



Installation Instructions

2. Pre-fit the FWD LHS Hinged Door Floor Protection, Assy (Item 1) & FWD RHS Sliding Door, Long Ling Floor Protection, Assy (Item 7) by lining up the outboard edge of the panel, assy with the existing floor panel edge. Reference Figure 2.

Note: Ensure clearance around cutout features, cyclic, collective, & pedals etc.

3. With the panel lined up use the pre-cut $\text{\O}.$ 25 holes and a felt pen to mark out the locations for the Velcro, Details (Items 6, 14 & 15) and remove the panels (Items 1 & 7). Reference Figure 2.

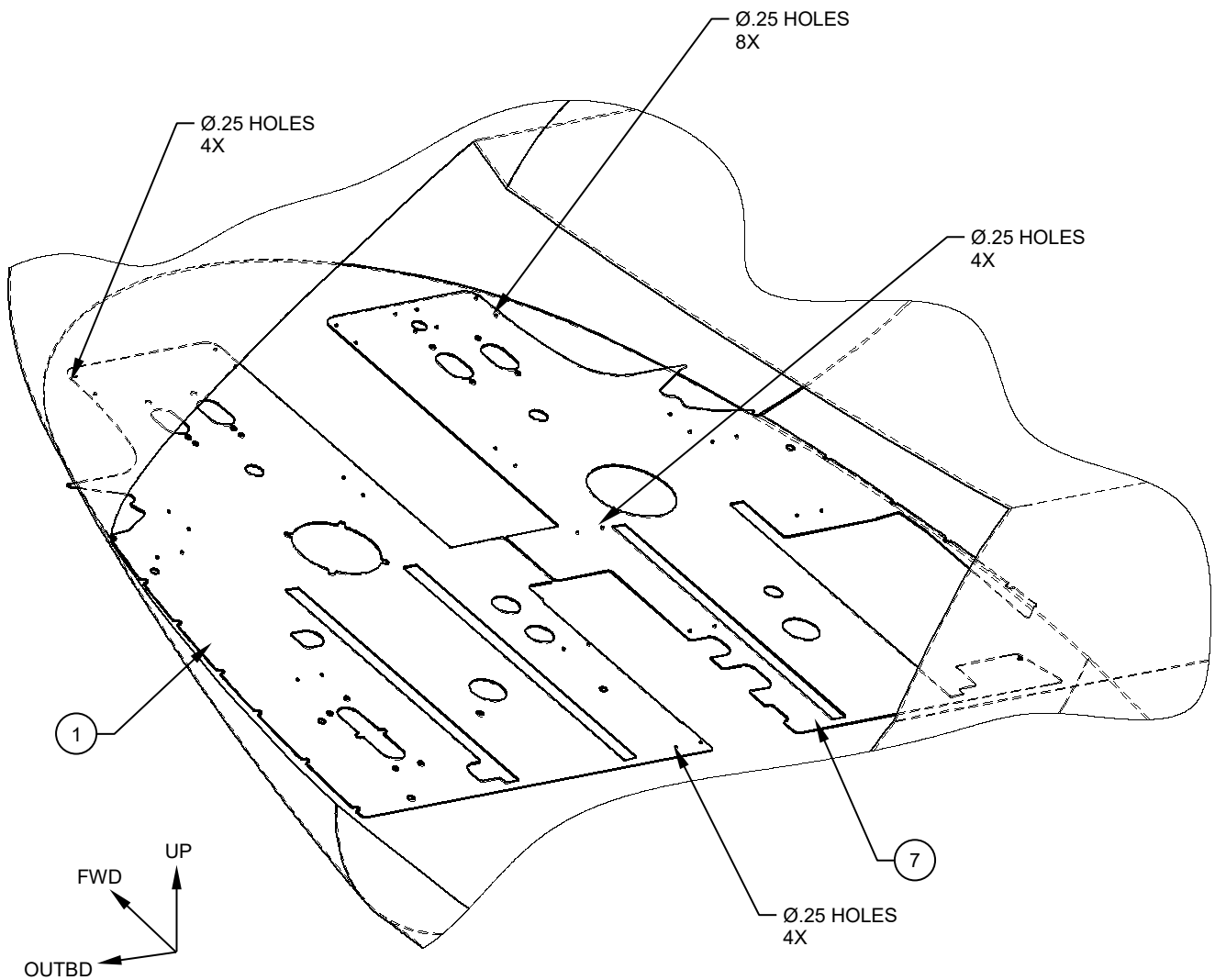

VIEW ORIENTATION
INSTALLATION SHOWN

Figure 2
Some Items
Removed for
Clarity



Installation Instructions

4. Clean the areas between the felt pen marks with alcohol taking care not to wipe away the felt pen marks.
5. Individually separate each Velcro, Detail (Item 6) off of the FWD LHS Sliding Door Floor Protection, Assy (Item 1) and Velcro, Detail (Items 14 & 15) off of the FWD RHS Sliding Door, Long Ling Floor Protection, Assy (Item 7) peel adhesive backing from the Velcro, Details (Items 6, 14 & 15).
6. Using the felt pen marks as reference points, apply the Velcro, Details (Items 6, 14 & 15) to the floor board panel in their respective locations. Reference Figure 3. Apply adequate pressure to ensure a secure bond.

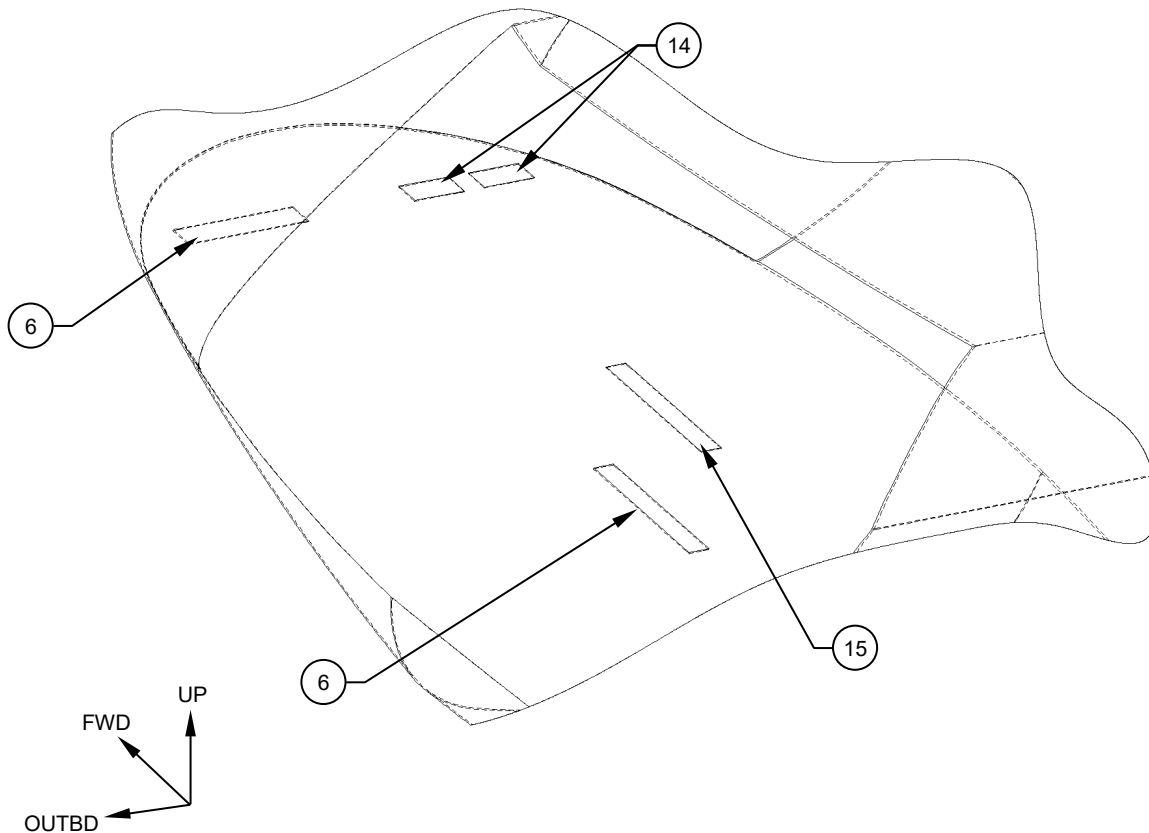

VIEW ORIENTATION
INSTALLATION SHOWN

Figure 3
Some Items
Removed for
Clarity

7. Re-install the FWD LHS Sliding Door Floor Protection, Assy (Item 1) & FWD RHS Sliding Door, Long Ling Floor Protection, Assy (Item 7) onto Velcro strips. Reference Figures 2 & 3.



Installation Instructions

8. Fit the AFT Sliding Door Floor Protection, Assy (Item 16) by lining up the outboard edge of the panel, assy with the existing floor panel edge on the LHS and picking up on the existing holes that hold down the sliding door transition sill. Reference Figure 4.

Note: Ensure clearance around cutout features, cyclic, collective, & pedals etc.

9. If required use a sharp utility knife to remove **EITHER** the FWD or AFT set of knock out rectangles to allow the Aft seats to be properly fastened. Reference Figure 4

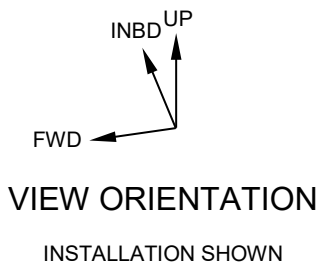
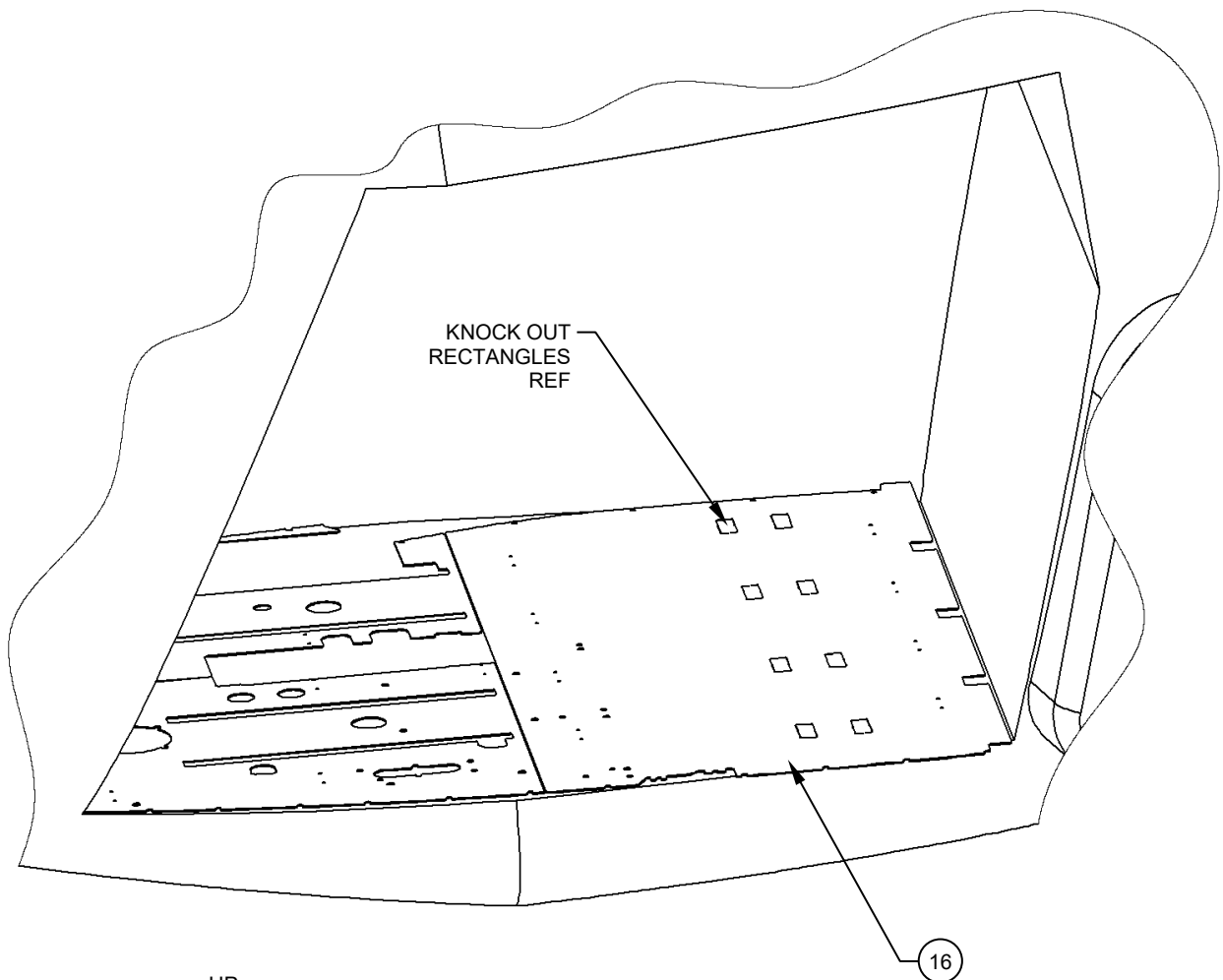
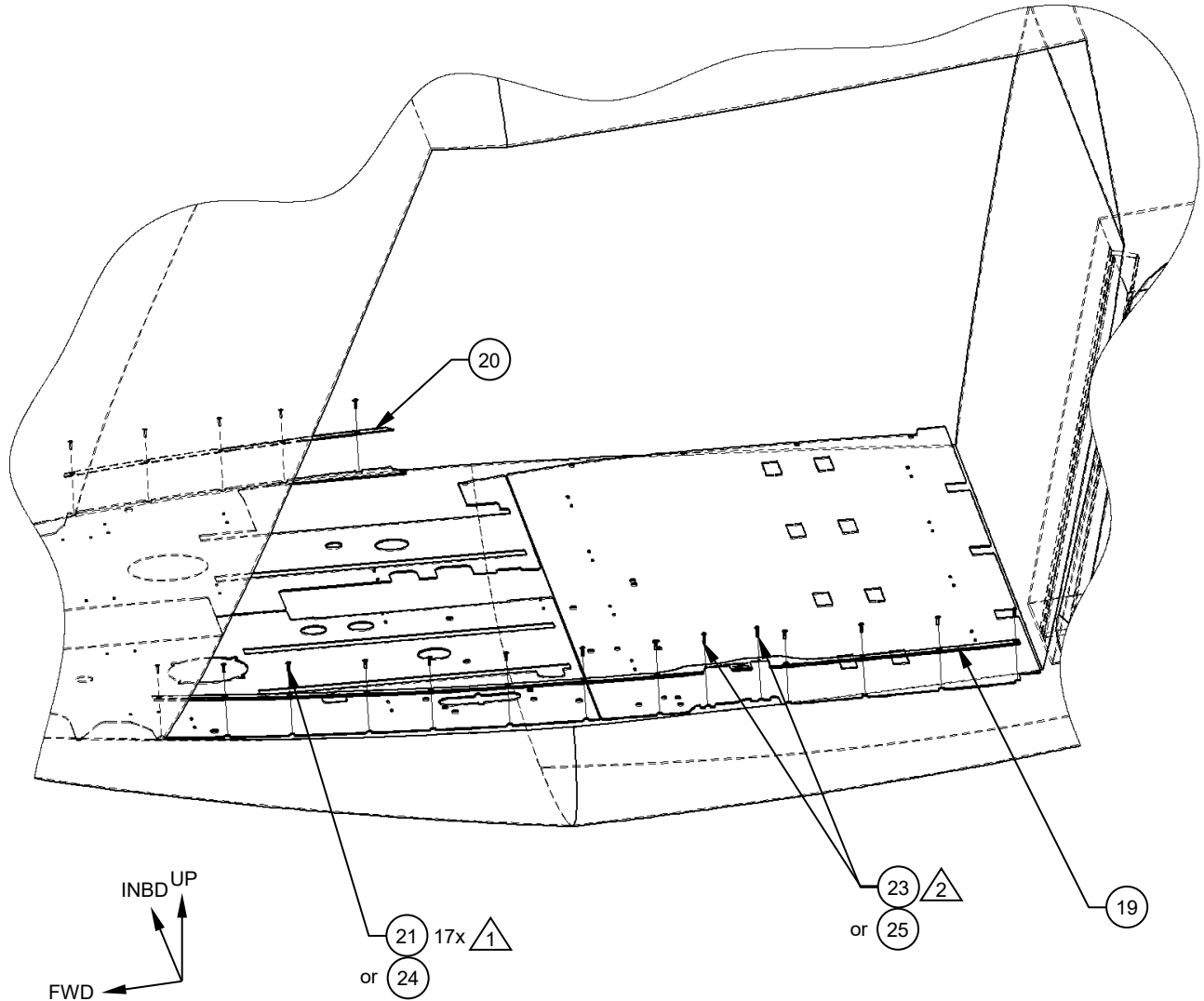

Figure 4
Some Items
Removed for
Clarity



Installation Instructions

10. Install Door Sill, Details (Items 19 & 20) as shown using supplied hardware Screw, Machine (Item 21) & Pan Head Philips, Machine Screw (Item 23). Reference Figure 5.



VIEW ORIENTATION

INSTALLATION SHOWN

Figure 5
Some Items
Removed for
Clarity



Installation Instructions

11. Re-install the sliding door transition sill over top of the AFT Sliding Door Floor Protection, Assy (Item 16) & FWD RHS Hinged Door Floor Protection, Assy (Item 7) and fasten with provided hardware, Screw, Machine (Item 23) & Washer, Flat (Item 22).

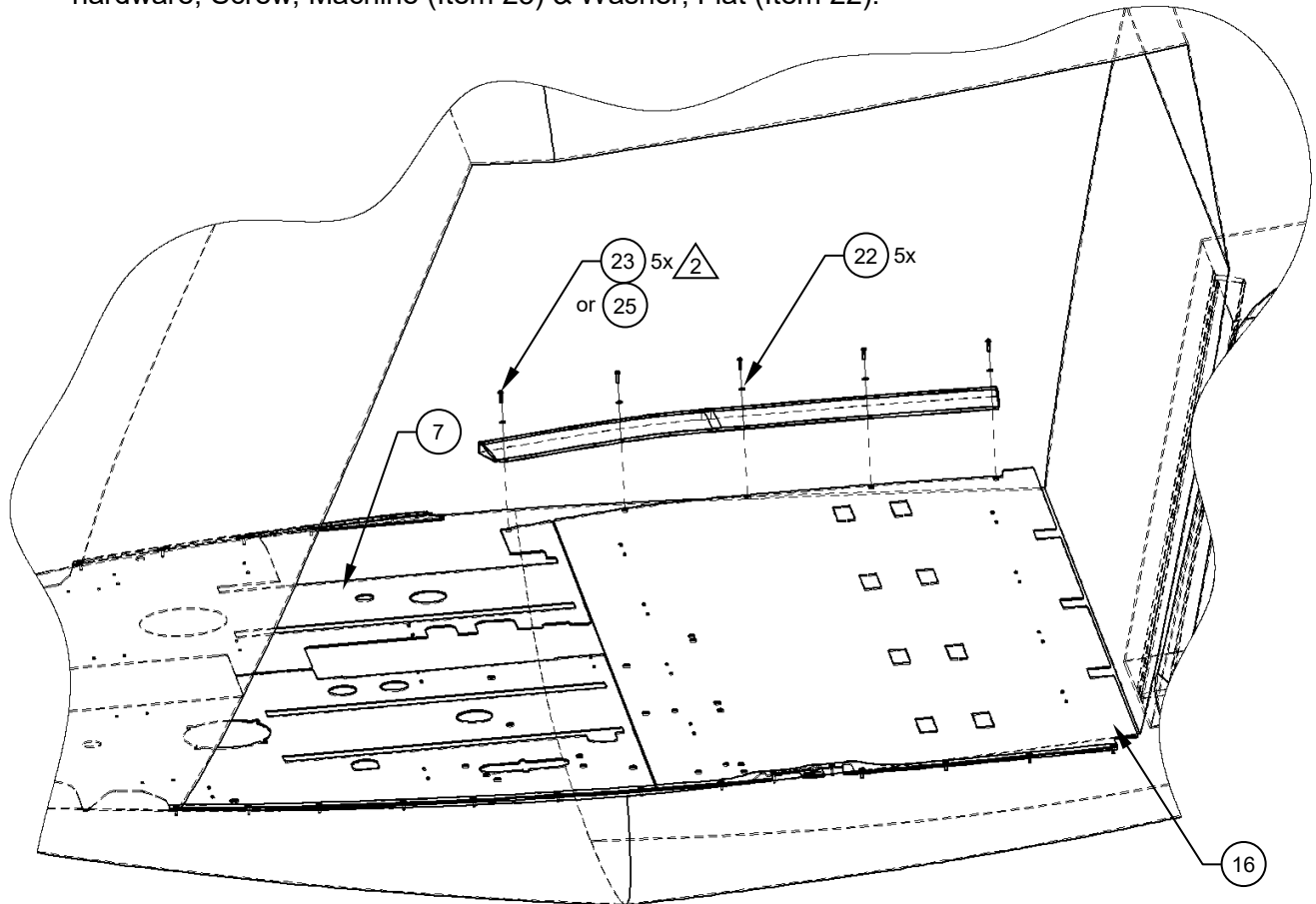

INBD UP
FWD
VIEW ORIENTATION
INSTALLATION SHOWN

Figure 6
Some Items
Removed for
Clarity



Installation Instructions

12. Suggested Grip Tape (Item 26), installation shown.

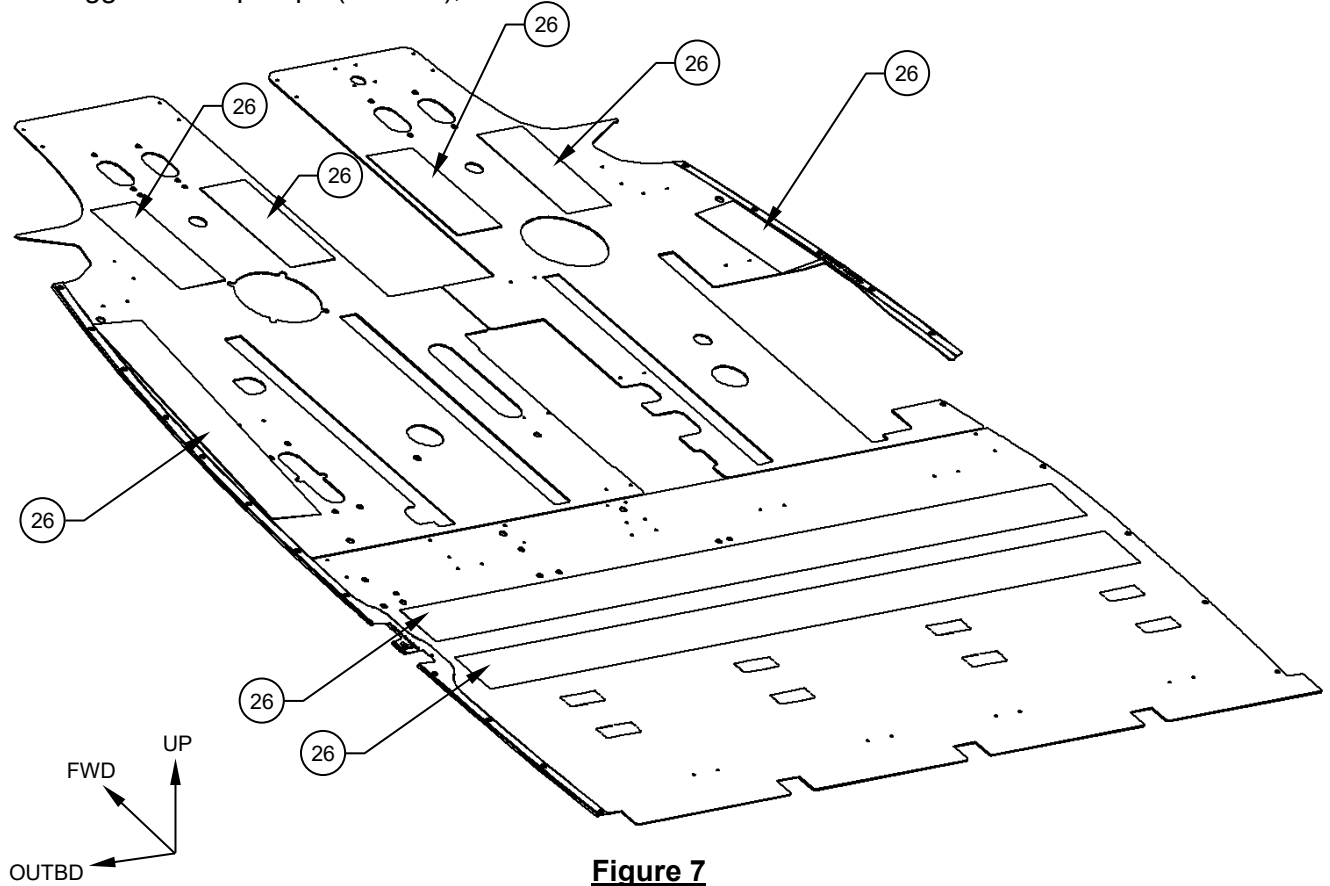

VIEW ORIENTATION
INSTALLATION SHOWN

Figure 7
Suggested Grip Tape (Item 26)
Installation Shown
Some Items
Removed for
Clarity

13. Installation complete

14. Perform a General Inspection of all items to ensure proper installation.

15. Update the aircraft logbook for the installation of RHS Sliding Door, Long Line Floor Protection, Kit.



Removal Instructions

1. For the removal the RHS Sliding Door, Long Line Floor Protection, Kit for either inspections, or mission configuration, the removal of the RHS Sliding Door, Long Line Floor Protection, Kit can be considered the opposite of installation for step 7 & 8. For permanent removal, of RHS Sliding Door, Long Line Floor Protection, Kit remove all bonded Velcro, Details.
2. Perform a General Inspection of all items to ensure proper removal.
3. Update the aircraft logbook for the removal of the RHS Sliding Door, Long Line Floor Protection, Kit.



Section 4: Illustrated Parts Breakdown

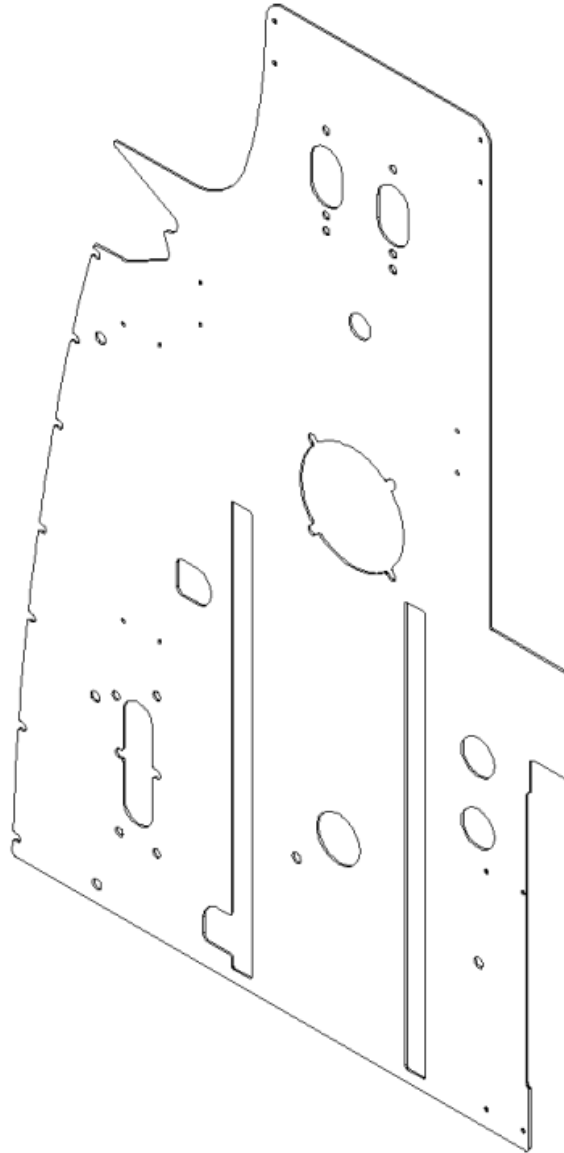

FWD LHS Sliding Door Floor Protection, Assy
Shown
Item 1

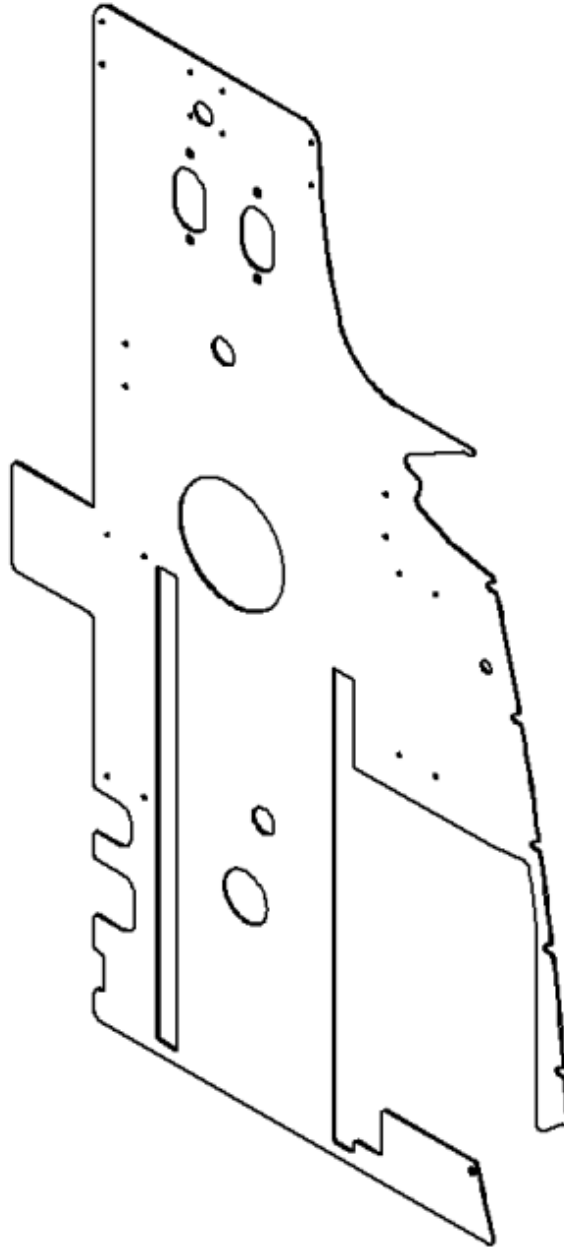

FWD RHS Sliding Door Floor Protection, Assy
Shown
Item 7

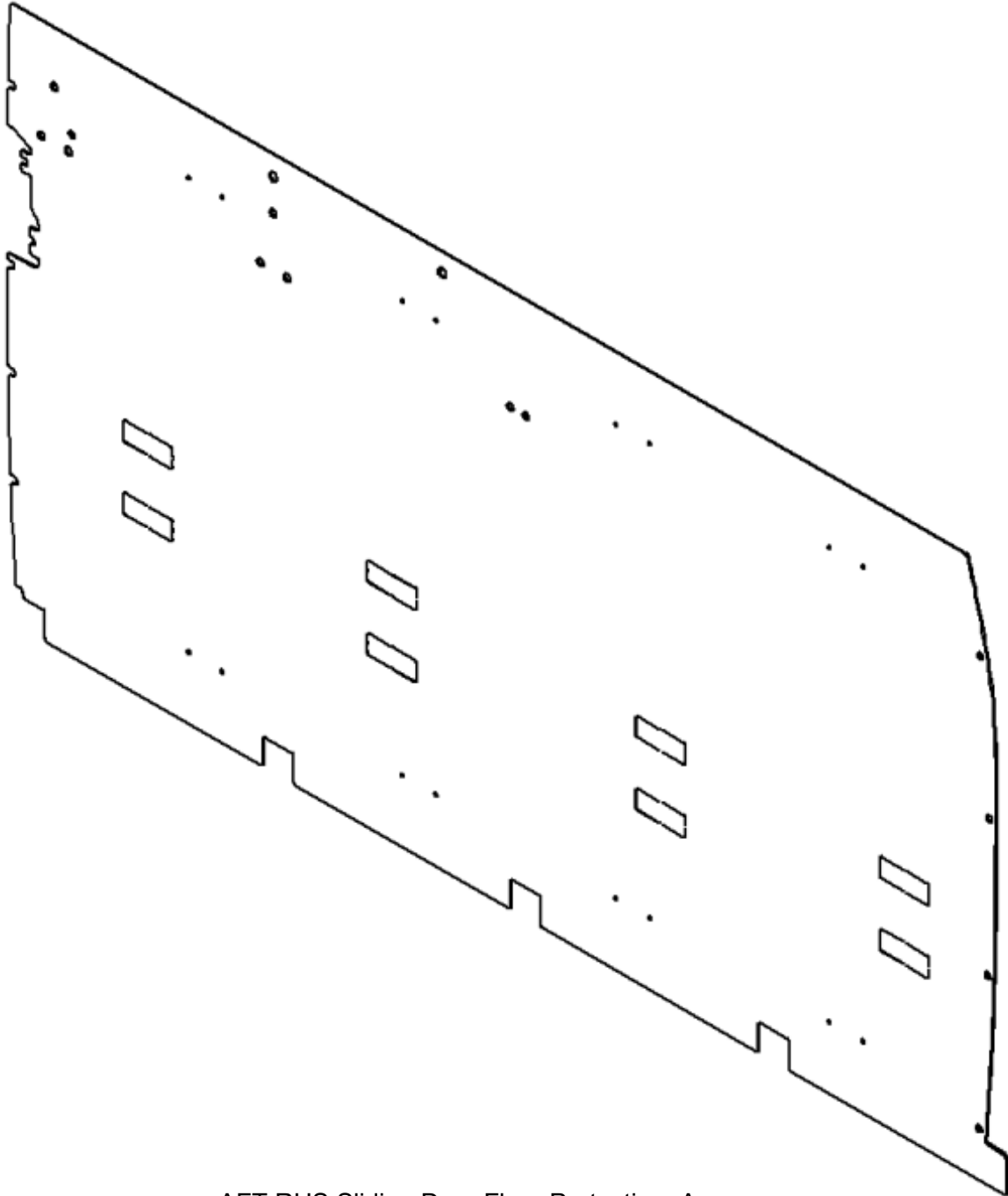

AFT RHS Sliding Door Floor Protection, Assy
Shown
Item 16

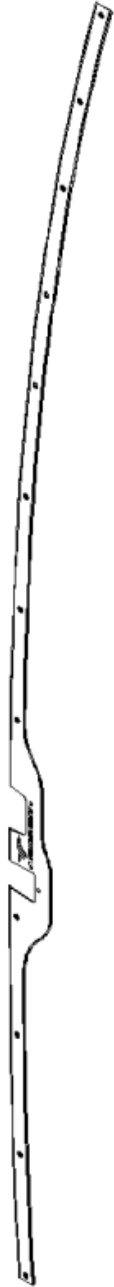

Door Sill, Detail
Shown
Item 19

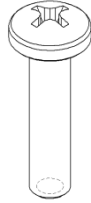

Pan Head Philips,
Machine Screw
Shown
Item 23
Item 25

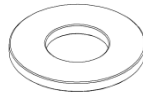

Washer, Flat
Shown
Item 22



Screw Machine
Shown
Item 21
Item 24



Door Sill, Detail
Shown
Item 20



Grip Tape
Shown
Item 26



ALPINE AEROTECH LP

www.alpineaerotech.com



1260 Industrial Road, Kelowna, B.C., Canada V1Z 1G5

Phone: (250) 769-6344 Fax: (250) 769-6303

admin@alpineaerotech.com

ITEM	QTY	NUMBER	DESCRIPTION	MATERIAL	REF STOCK SIZE	SPEC	FINISH	MANUFACTURER	NCAGEC
-	-	AAL-312-020-008	RHS SLIDING DOOR, LONG LINE FLOOR BOARD, KIT	C/O SHADED ITEMS ONLY					
1	1	AAL-312-021-011	FWD LHS HINGED DOOR FLOOR PROTECTION, ASSY	NA	NA	NA	NA	ALPINE AEROTECH LP	L0171
2	1	AAL-312-021-001	FWD LHS HINGED DOOR FLOOR PROTECTION, ASSY	NA	NA	NA	NA	ALPINE AEROTECH LP	L0171
3	1	AAL-312-022-001	FWD LHS HINGED DOOR FLOOR PROTECTION, DETAIL	NA	NA	NA	NA	ALPINE AEROTECH LP	L0171
4	2	151394	VELCRO, DETAIL	LOOP 1000, BLACK, 8224 PSA	2 X 12.00	SEE MFR	SEE MFR	VELCRO USA INC.	11153
5	2	151394	VELCRO, DETAIL	LOOP 1000, BLACK, 8224 PSA	2 X 15.00	SEE MFR	SEE MFR	VELCRO USA INC.	11153
6	2	151405	VELCRO, DETAIL	HOOK 88, BLACK 8289 PSA	2 x 12.00	SEE MFR	SEE MFR	VELCRO USA INC.	11153
7	1	AAL-312-021-016	FWD RHS SLIDING DOOR, LONG LINE FLOOR PROTECTION, ASSY	NA	NA	NA	NA	ALPINE AEROTECH LP	L0171
8	1	AAL-312-021-010	FWD RHS SLIDING DOOR, LONG LINE FLOOR PROTECTION, ASSY	NA	NA	NA	NA	ALPINE AEROTECH LP	L0171
9	1	AAL-312-022-010	FWD RHS SLIDING LONG LINE DOOR FLOOR PROTECTION, DETAIL	NA	NA	NA	NA	ALPINE AEROTECH LP	L0171
10	2	151394	VELCRO, DETAIL	LOOP 1000, BLACK, 8224 PSA	2 x 5.00	SEE MFR	SEE MFR	VELCRO USA INC.	11153
11	1	151394	VELCRO, DETAIL	LOOP 1000, BLACK, 8224 PSA	2 X 15.00	SEE MFR	SEE MFR	VELCRO USA INC.	11153
12	1	151394	VELCRO, DETAIL	LOOP 1000, BLACK, 8224 PSA	2 X 9.00	SEE MFR	SEE MFR	VELCRO USA INC.	11153
13	1	151394	VELCRO, DETAIL	LOOP 1000, BLACK, 8224 PSA	2 X 12.00	SEE MFR	SEE MFR	VELCRO USA INC.	11153
14	2	151405	VELCRO, DETAIL	HOOK 88, BLACK 8289 PSA	2 x 5.00	SEE MFR	SEE MFR	VELCRO USA INC.	11153
15	1	151405	VELCRO, DETAIL	HOOK 88, BLACK 8289 PSA	2 x 12.00	SEE MFR	SEE MFR	VELCRO USA INC.	11153



ALPINE AEROTECH LP

www.alpineaerotech.com



1260 Industrial Road, Kelowna, B.C., Canada V1Z 1G5

Phone: (250) 769-6344 Fax: (250) 769-6303

admin@alpineaerotech.com

ITEM	QTY	NUMBER	DESCRIPTION	MATERIAL	REF STOCK SIZE	SPEC	FINISH	MANUFACTURER	NCAGEC
-	-	AAL-312-020-008	RHS SLIDING DOOR, LONG LINE FLOOR BOARD, KIT	C/O SHADED ITEMS ONLY					
16	1	AAL-312-021-008	AFT RHS SLIDING DOOR FLOOR PROTECTION, ASSY	NA	NA	NA	NA	ALPINE AEROTECH LP	L0171
17	1	AAL-312-022-008	AFT RHS SLIDING DOOR FLOOR PROTECTION, DETAIL	NA	NA	NA	NA	ALPINE AEROTECH LP	L0171
18	4	151394	VELCRO, DETAIL	LOOP 1000, BLACK, 8224 PSA	2 X 26.00	SEE MFR	SEE MFR	VELCRO USA INC.	11153
19	1	AAL-312-022-011	DOOR SILL, DETAIL	NA	NA	NA	NA	ALPINE AEROTECH LP	L0171
20	1	AAL-312-022-014	DOOR SILL, DETAIL	NA	NA	NA	NA	ALPINE AEROTECH LP	L0171
21	17	ISO 7046-1-M4 x 16	SCREW, MACHINE	SEE SPEC	SEE SPEC	ISO 7046-1	SEE SPEC	SOURCE AS REQUIRED	NA
22	5	NAS1149CN832R	WASHER, FLAT	SEE SPEC	SEE SPEC	NAS1149	SEE SPEC	SOURCE AS REQUIRED	NA
23	7	ISO 7045-M4 x 18	PAN HEAD PHILLIPS, MACHINE SCREW	SEE SPEC	SEE SPEC	ISO 7045	SEE SPEC	SOURCE AS REQUIRED	NA
24	17	MS24693-S273	SCREW, MACHINE	SEE SPEC	SEE SPEC	NAS24693	SEE SPEC	SOURCE AS REQUIRED	NA
25	7	MS35207-265	PAN HEAD PHILLIPS, MACHINE SCREW	SEE SPEC	SEE SPEC	NASM35206	SEE SPEC	SOURCE AS REQUIRED	NA
26	1	3M SAFETY-WALK SLIP-RESISTANT GENERAL PURPOSE TAPES AND TREADS 620, CLEAR 4in - 70070975621	SAFETY-WALK GENERAL PURPOSE GRIP TAPE	POLY-URETHANE	188.00"	NA	NFSI SCOF < 0.60	3M	NA