

HINGED DOOR FLOOR PROTECTION, KIT INSTRUCTIONS FOR CONTINUING AIRWORTHINESS

MODELS: EUROCOPTER AS350*

*With AFT LHS RHS hinged doors installed

Read all of the Instructions for Continuing Airworthiness thoroughly prior to performing any activities relating to this product



Table of Contents

<u>Section</u>	<u>Description</u>	<u>Page</u>
1	Description	2
2	Maintenance Manual Supplement	3
3	Installation & Removal Instructions	8
	Installation Instructions	9
	Removal Instructions	16
4	Illustrated Parts Breakdown	17

Notes

1. If changes to this document are required, Alpine Aerotech LP shall revise all pages and reissue the entire document.
2. Alpine Aerotech LP shall make any subsequent revisions of this document available free of charge upon request. Alpine Aerotech LP also recommends that the end user of this product periodically verify the revision level of this document.

Section 1: Description

Description

The following information provides a functional description of the Hinged Door Floor Protection, Kit as defined in Alpine Aerotech LP authority dataset AAL-312-020-001.

- The Floor Protection, Kits are rigid pieces of material that are installed atop the existing floor to protect it from dents and punctures associated with typical aircraft usage. This occurs most frequently during loading and unloading operations, but can also occur during small inflight shifts of said cargo.
- The Hinged Door Floor Protection, Kit when installed, adds additional protection to the floor panels, as it is manufactured from a material specifically designed to spread and attenuate energy.



Section 2: Maintenance Manual Supplement

General Notes

1. The following information defines the instructions for continuing airworthiness, repair allowances and airworthiness limitations for the item(s) referenced within this document.
2. Refer to the current revisions of the Eurocopter AS350 Master Service Manual for Instructions for Maintenance/Inspection with respect to the item(s) referenced within this document.
3. Refer to the Section 3: Installation & Removal Instructions and Section 4: Illustrated Parts Breakdown for the replacement and/or installation of the item(s) referenced within this section.
4. Scheduled inspection for the item(s) referenced within this document shall be accomplished in accordance with (IAW) the Inspection Procedures specified.
5. Repair allowances for the item(s) referenced within this document shall be accomplished IAW the Repair Procedures specified.
6. Limitations for the item(s) referenced within this document are IAW the Airworthiness Limitations specified.



Airworthiness Limitations

The Airworthiness Limitations section is approved by the Minister and specifies maintenance required by any applicable airworthiness or operating rule unless an alternative program has been approved by the Minister.

The Airworthiness Limitations section is FAA approved and specifies maintenance required under Sections 43.16 and 91.403 of the Federal Aviation Regulations unless an alternative program has been FAA approved.

Supplement to applicable Maintenance Manual, Chapter 4, Airworthiness Limitations Schedule

Notes

1. Refer to the applicable Master Service Manual, Chapters, for general information on airworthiness limitations and airworthiness limitation schedules.
2. Item(s) **not** listed in the Scheduled Airworthiness Limitations section within this document have an unlimited airworthiness life.

Scheduled Airworthiness Limitations

1. There are no airworthiness limitations associated with the item(s) referenced within this document.



Inspection Procedures

Supplement to applicable Maintenance Manual, Chapter 5, Inspection and Component Overhaul Schedule

Notes

1. Refer to the applicable Master Service Manual, Breakdown of the MSM Section 7, for general information on inspections, inspection definitions, inspection intervals, inspection methods and inspection schedules.
2. General Inspections, as indicated within this document, are defined as visual, non-thorough checks.
3. Detailed Inspections, as indicated within this document, are defined as visual and thorough, searching checks.
4. Perform Daily Inspections every day, prior to flight operation. If damage is detected, perform the 150 Hour/12 Month Inspections.
5. Perform 150 Hour/12 Month Inspections every 150 hours or every 12 months, whichever occurs first, prior to flight operation. If damage is detected, refer to the Repair Procedures section within this document.

Scheduled Inspections

1. Daily Inspections

Data Reference: Section 3: Installation and Removal Instructions
Section 4: Illustrated Parts Breakdown

- i. Perform a General Inspection on the Hinged Door Floor Protection, Kit, Installation for general condition.
- ii. Perform a General Inspection on the Hinged Door Floor Protection, Kit, Installation for proper security.



Scheduled Inspections

2. 150 Hour/12 Month Inspections

Data Reference: Section 3: Installation and Removal Instructions
Section 4: Illustrated Parts Breakdown

- I. Perform a Detailed Inspection on all items to ensure proper security.
- II. Perform a Detailed Inspection on all items/materials to ensure proper integrity.
- III. Perform a Detailed Inspection on the Hinged Door Floor Protection, Kit to ensure that it is not delaminating.
- IV. Perform a Detailed Inspection on all surfaces & locations with Velcro applied to ensure no damage has occurred to the aircraft floor.



ALPINE AEROTECH LP

www.alpineaerotech.com



1260 Industrial Road, Kelowna, B.C., Canada V1Z 1G5

Phone: (250) 769-6344 Fax: (250) 769-6303

admin@alpineaerotech.com

Repair Procedures

1. Repairs to the item(s) referenced within this document are **not** permitted. Contact Alpine Aerotech LP for further information if repairs are required to the item(s) referenced within this document.



Section 3: Installation & Removal Instructions

Weight & Balance

<u>Part Number</u>	<u>Description</u>	<u>Weight</u>	<u>Long. Arm</u>	<u>Lat. Arm</u>
AAL-312-020-001	Hinged Door Floor Protection, Kit	15.23*	69.622	.061 LBL
		6.906 (Kg)	1.768 (m)	.002 (m)

* Total increase in weight to aircraft.

General Notes

1. All Installation Instructions shall be accomplished IAW standard aircraft practices. Refer to the current revision of the FAA publications AC 43.13-1B and AC 43.13-2B for details on standard aircraft practices.
2. All Dimensions are in imperial measures (inches/pounds).
3. Refer to Section 2: Maintenance Manual Supplement for instructions on maintenance for the item(s) referenced within this section.
4. Refer to the Section 4: Illustrated Parts Breakdown for the part numbers of the item(s) referenced within this section.



Alternate Part: DIN965-M4 x 16



Alternate Part: DIN7985-M4 x 18



Installation Instructions

1. Gain access to the cabin floor, temporarily remove all seats, LHS collective, & foot pedals. Remove any existing floor board protection kits, door sills and door sill fasteners. Reference Figure 1.

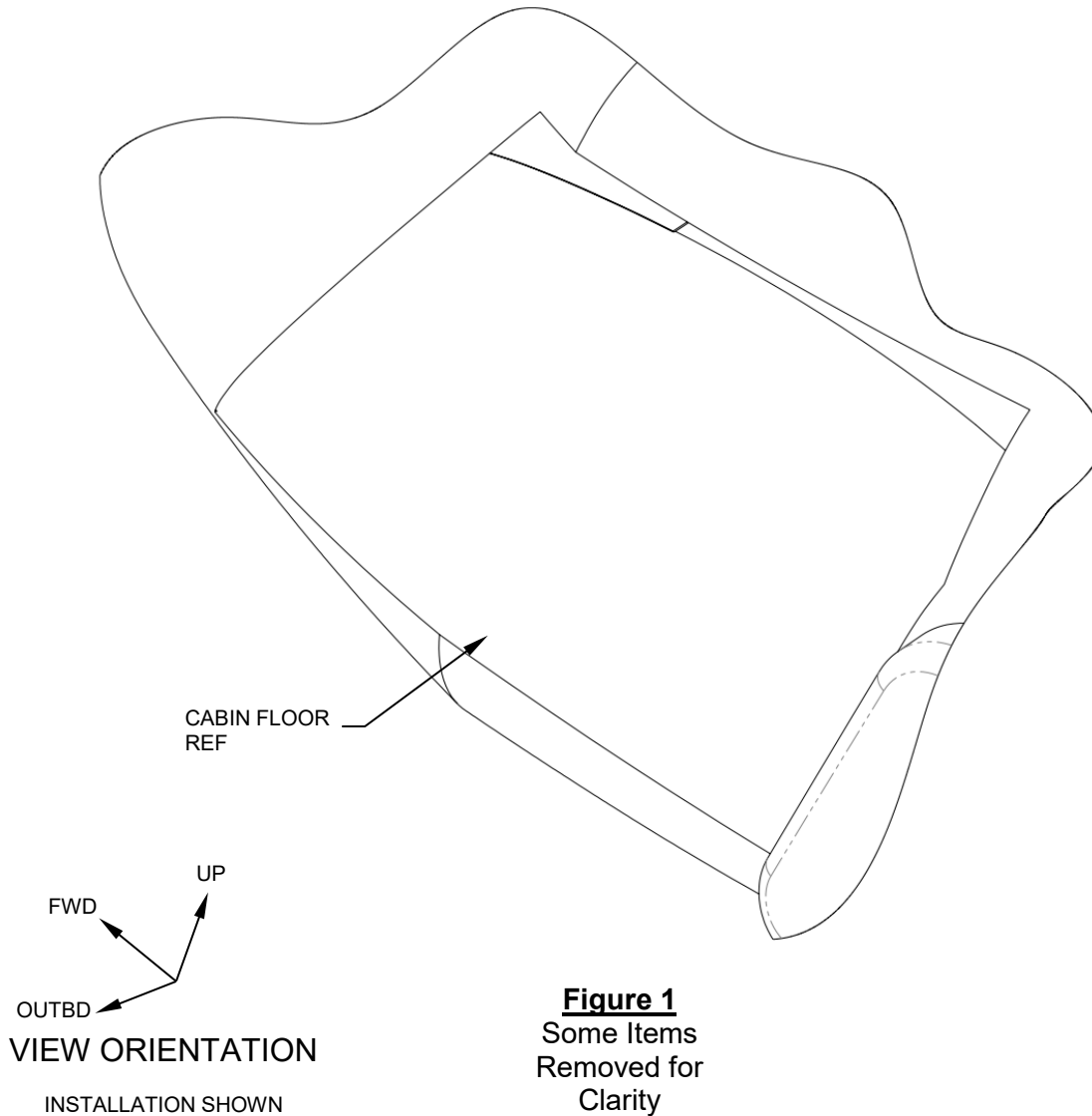



Installation Instructions

2. Pre-fit the FWD LHS Hinged Door Floor Protection, Assy (Item 1), FWD RHS Hinged Door Floor Protection, Assy (Item 13), & AFT Hinged Door Floor Protection, Assy (Item 23) by lining up the outboard edge of the panel, assy with the existing floor panel edge. Reference Figure 2.

Note: Ensure clearance around cutout features, cyclic, collective, & pedals etc.

3. With the panel lined up use the pre-cut $\text{\O} .25$ holes and a felt pen to mark out the locations for the Velcro, Details (Items 9, 10, 11, 12, 20, 21, 22, 29, & 30) and remove the panels (Items 1, 13, & 23). Reference Figure 2 & 3.

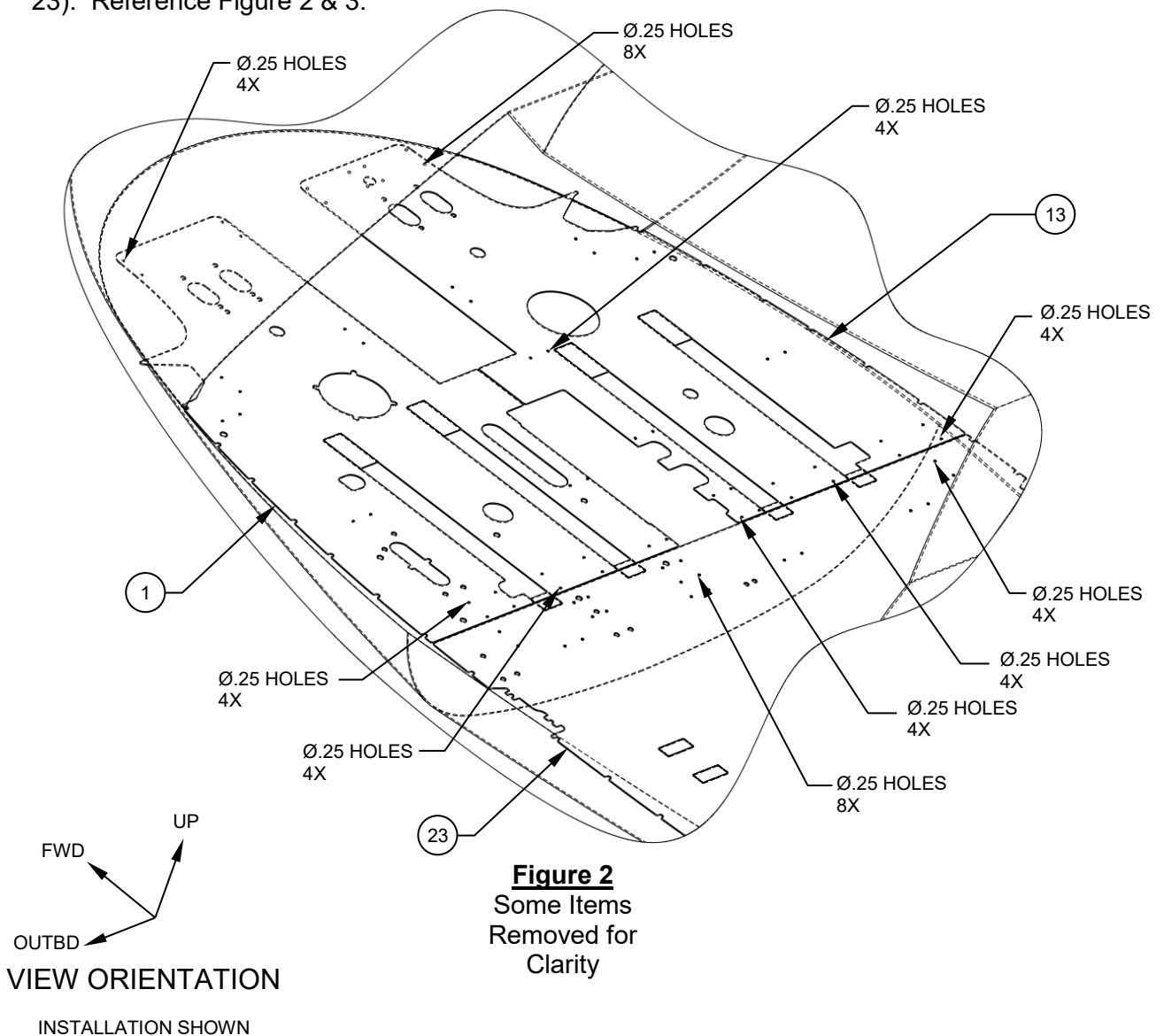



Installation Instructions

4. Clean the areas between the felt pen marks with alcohol taking care not to wipe away the felt pen marks.
5. Individually separate each Velcro, Detail (Items 9, 10, 11, & 12) off of the FWD LHS Hinged Door Floor Protection, Assy (Item 1), Velcro, Detail (Items 20, 21, & 22) off of the FWD RHS Hinged Door Floor Protection, Assy (Item 13), & Velcro, Detail (Items 29 & 30) off the AFT Hinged Door Floor Protection, Assy (Item 23), peel adhesive backing from the Velcro, Details (Items 9, 10, 11, 12, 20, 21, 22, 29, & 30).
6. Using the felt pen marks as reference points, apply the Velcro, Details (Items 9, 10, 11, 12, 20, 21, 22, 29, & 30) to the floor protection panel in their respective locations. Reference Figure 3. Apply adequate pressure to ensure a secure bond.

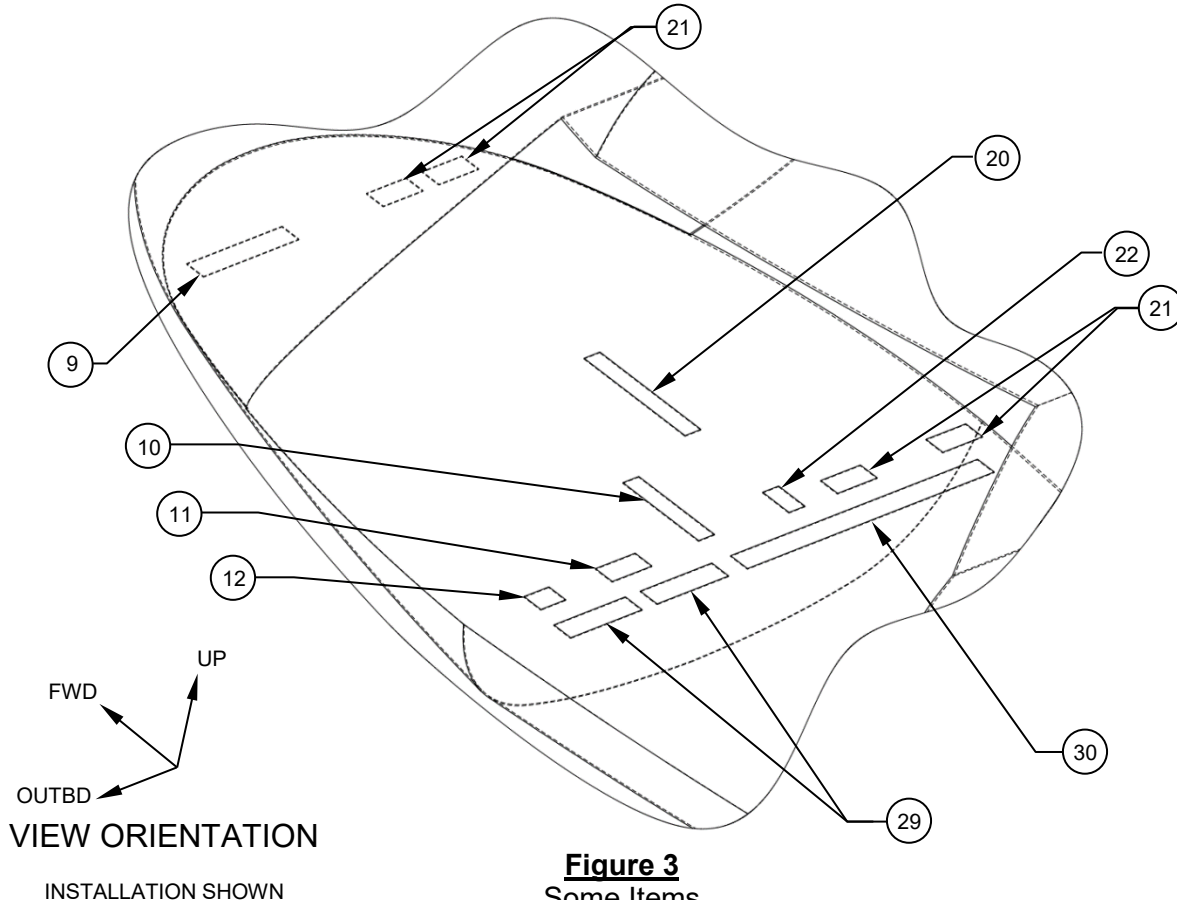



Installation Instructions

7. Re-install the FWD LHS Hinged Door Floor Protection, Assy (Item 1), FWD RHS Hinged Door Floor Protection, Assy (Item 13), & AFT Hinged Door Floor Protection, Assy (Item 23) onto Velcro strips. Reference Figures 2 & 3.
8. If required, use a sharp utility knife to remove the knock-out rectangles for FWD seats to fit your pilot and co-pilot seat configuration. Be careful not to score the aircraft floor panel with the knife. Reference Figure 4.
9. If required, use a sharp utility knife to remove **EITHER** the FWD or AFT set of knock-out rectangles to allow the AFT seats to be properly fastened. Be careful not to score the aircraft floor panel with the knife. Reference Figure 4.

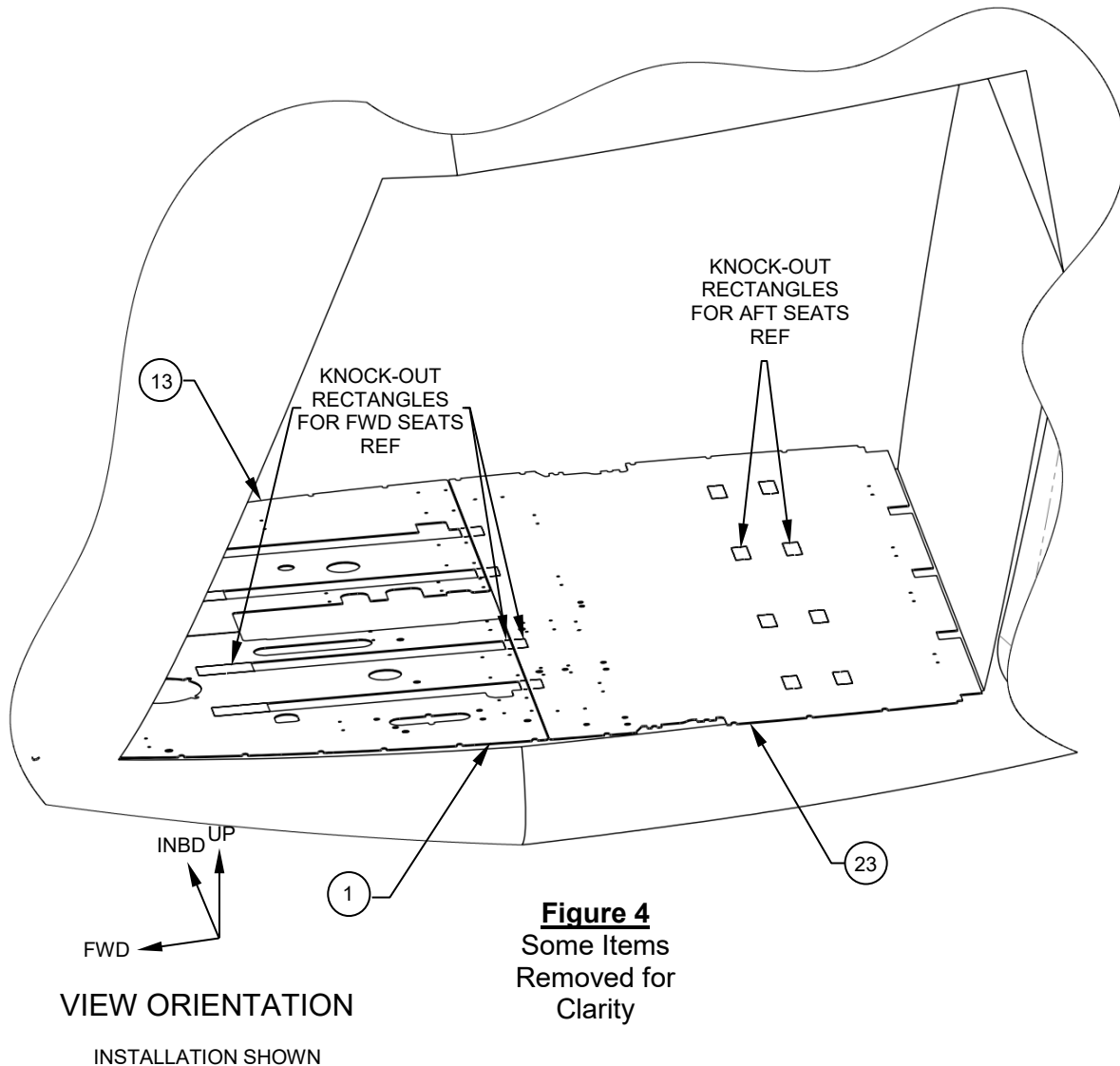



Installation Instructions

10. Install Door Sill, Details (Items 31 & 32) as shown. Reference Figure 5.

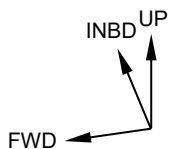
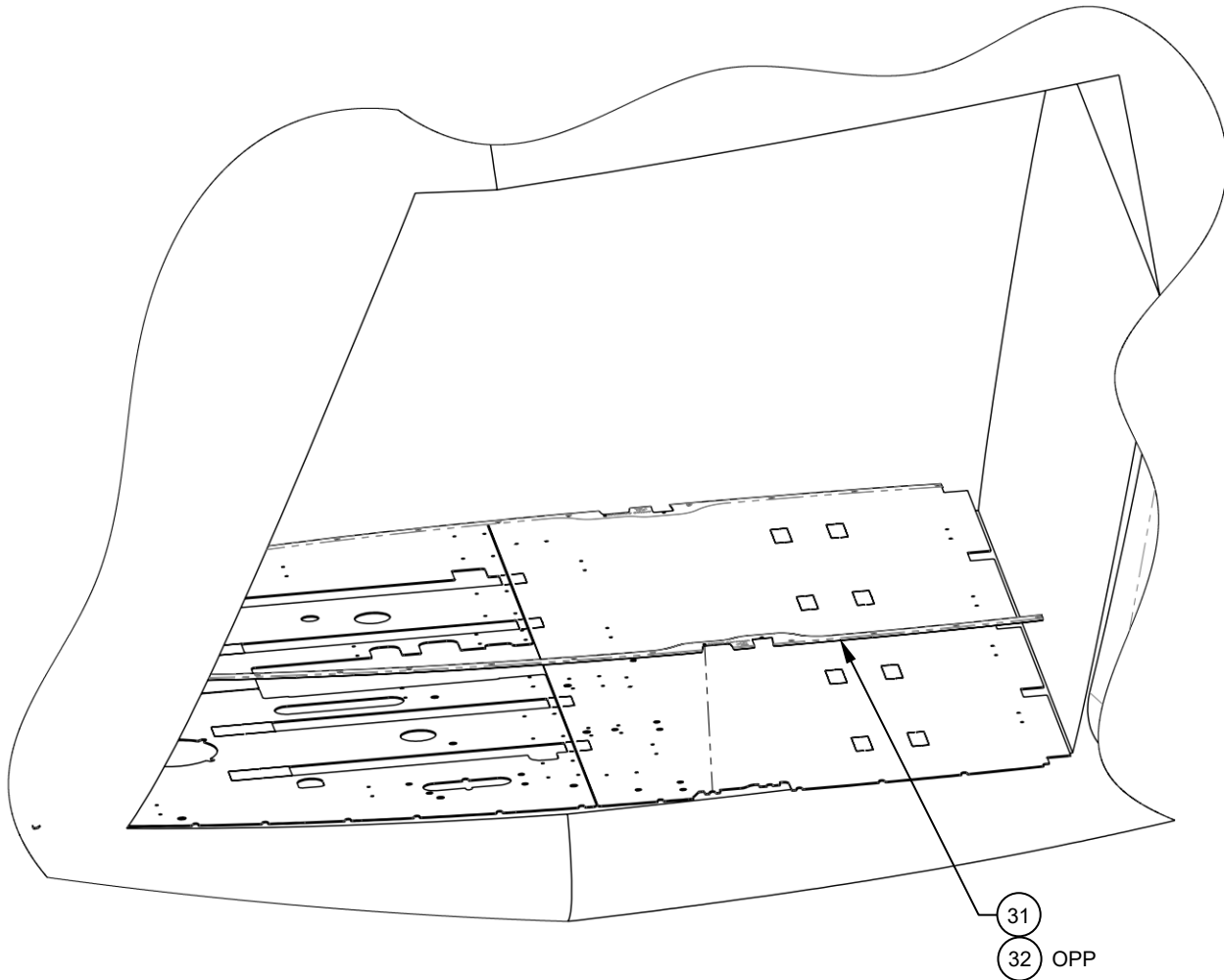

VIEW ORIENTATION

INSTALLATION SHOWN

Figure 5
LHS Shown RHS Opposite
Some Items
Removed for
Clarity



Installation Instructions

11. Install fasteners as shown. Reference Figure 6.

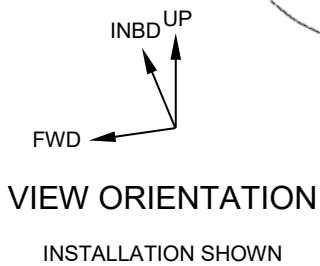
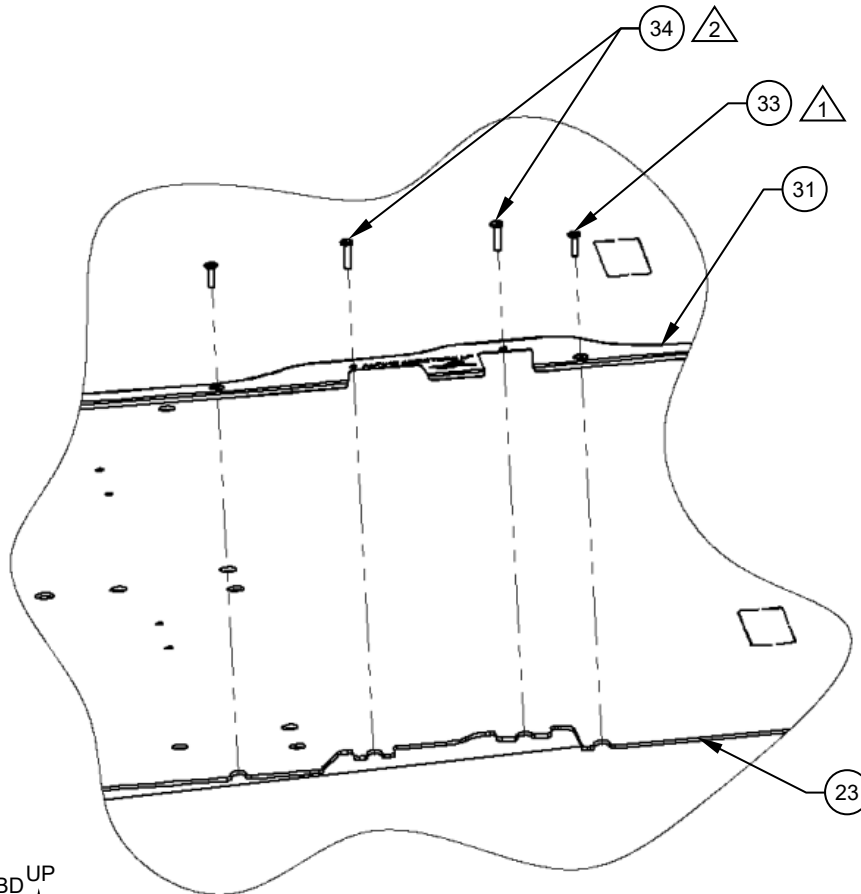
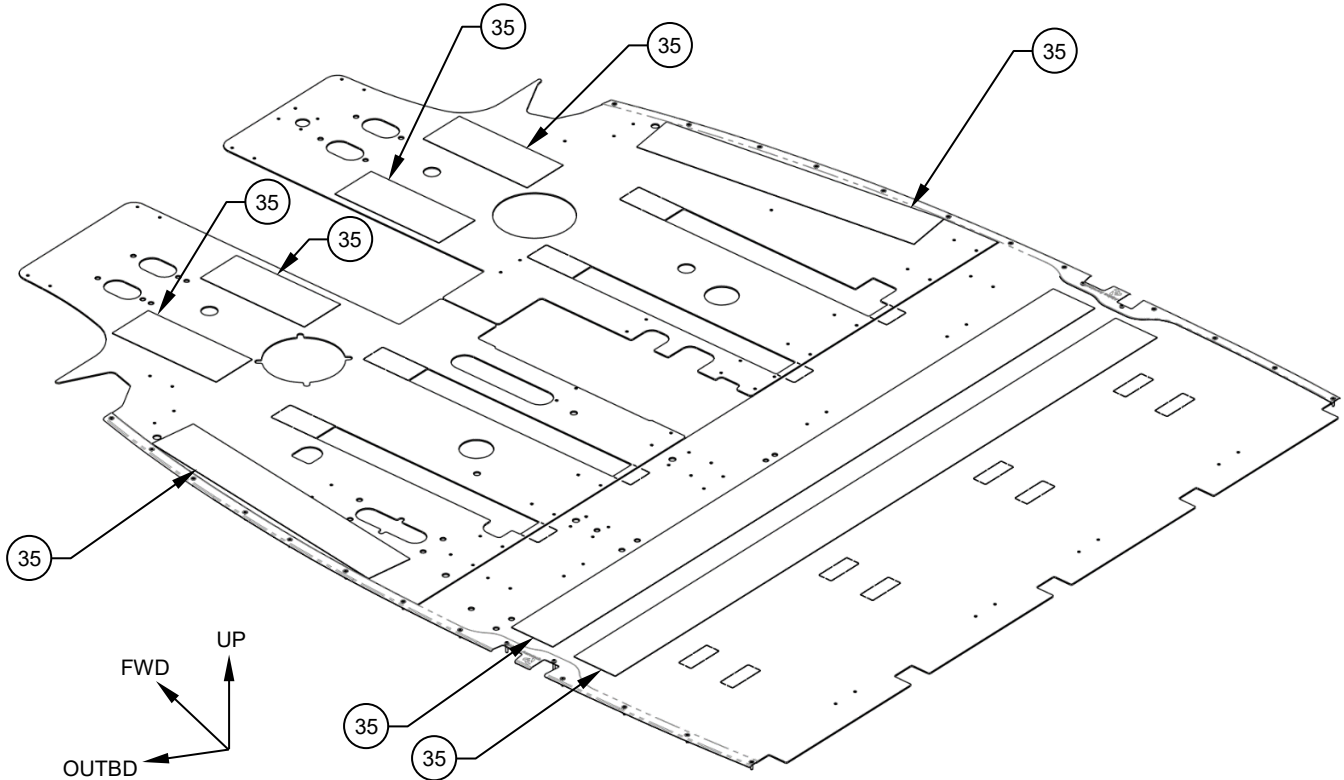

Figure 6
LHS Shown RHS Opposite
Some Items
Removed for
Clarity



Installation Instructions

12. Suggested Grip Tape (Item 35), installation shown.



VIEW ORIENTATION
INSTALLATION SHOWN

Figure 7
Suggested Grip Tape (Item 35)
Installation Shown
Some Items
Removed for
Clarity

13. Installation complete

14. Perform a General Inspection of all items to ensure proper installation.

15. Update the aircraft logbook for the installation of Hinged Door Floor Protection, Kit.



Removal Instructions

1. For the removal the Hinged Door Floor Protection, Kit for either inspections, or mission configuration, the removal of the Hinged Door Floor Protection, Kit can be considered the opposite of installation for step 7, 8 & 9. For permanent removal, of Hinged Door Floor Protection, Kit remove all bonded Velcro, Details.
2. Perform a General Inspection of all items to ensure proper removal.
3. Update the aircraft logbook for the removal of the Hinged Door Floor Protection, Kit.



Section 4: Illustrated Parts Breakdown

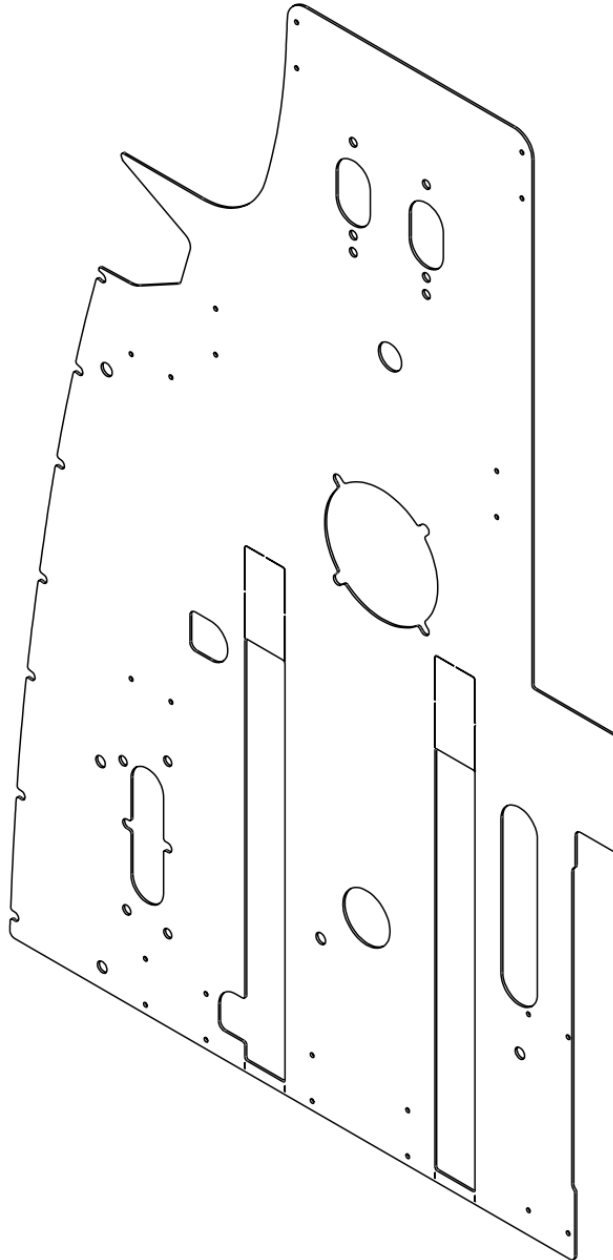

FWD LHS Hinged Door Floor Protection, Assy
Shown
Item 1

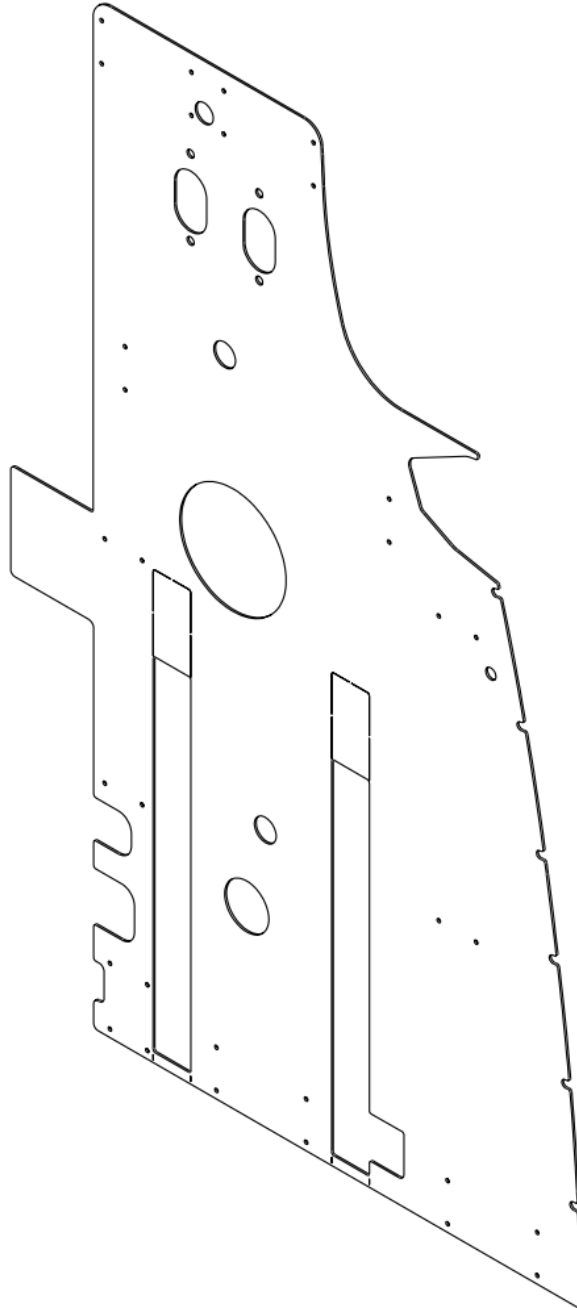

FWD RHS Hinged Door Floor Protection, Assy
Shown
Item 13

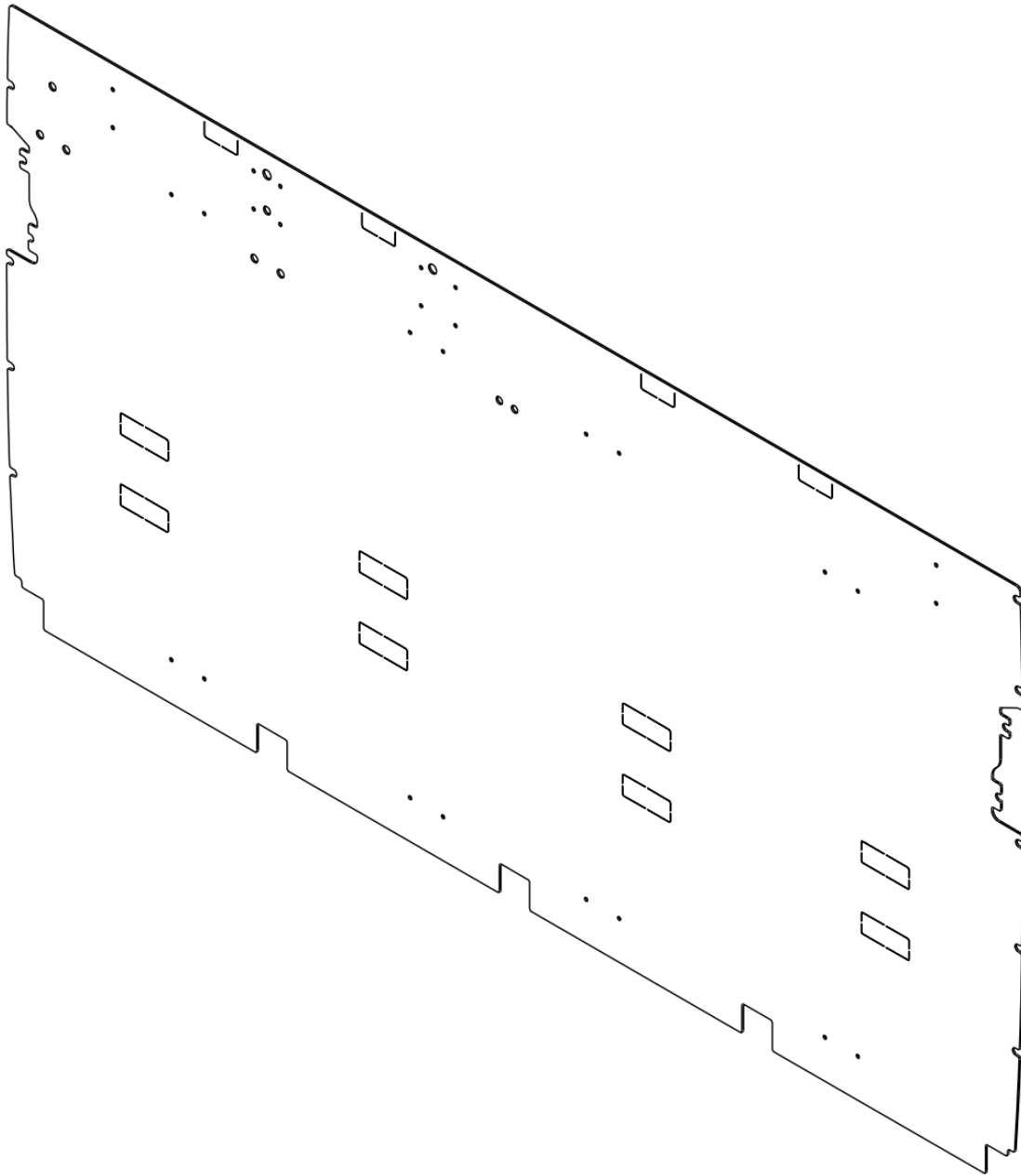

AFT Hinged Door Floor Protection, Assy
Shown
Item 23



Door Sill, Detail
Shown
Item 31

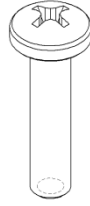

Pan Head Phillips,
Machine Screw
Shown
Item 34



Door Sill, Detail
Shown
Item 32

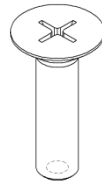

Screw Machine
Shown
Item 33



Grip Tape
Shown
Item 35



ALPINE AEROTECH LP

www.alpineaerotech.com



1260 Industrial Road, Kelowna, B.C., Canada V1Z 1G5
Phone: (250) 769-6344 Fax: (250) 769-6303
admin@alpineaerotech.com

ITEM	QTY	NUMBER	DESCRIPTION	MATERIAL	REF STOCK SIZE	SPEC	FINISH	MANUFACTURER	NCAGEC
-	-	AAL-312-020-001	HINGED DOOR FLOOR PROTECTION, KIT	C/O SHADED ITEMS ONLY					
1	1	AAL-312-021-011	FWD LHS HINGED DOOR FLOOR PROTECTION, ASSY	NA	NA	NA	NA	ALPINE AEROTECH LP	L0171
2	1	AAL-312-021-001	FWD LHS HINGED DOOR FLOOR PROTECTION, ASSY	NA	NA	NA	NA	ALPINE AEROTECH LP	L0171
3	1	AAL-312-022-001	FWD LHS HINGED DOOR FLOOR PROTECTION, DETAIL	P2C W/TUFFCOAT B/SIDES	0.1	SEE MFR	SEE MFR	ALPINE AEROTECH LP	L0171
4	1	151394	VELCRO, DETAIL	LOOP 1000, BLACK, 8224 PSA	2 X 12.00	SEE MFR	SEE MFR	VELCRO USA INC.	11153
5	1	151394	VELCRO, DETAIL	LOOP 1000, BLACK, 8224 PSA	2 X 9.00	SEE MFR	SEE MFR	VELCRO USA INC.	11153
6	2	151394	VELCRO, DETAIL	LOOP 1000, BLACK, 8224 PSA	2 X 15.00	SEE MFR	SEE MFR	VELCRO USA INC.	11153
7	1	151394	VELCRO, DETAIL	LOOP 1000, BLACK, 8224 PSA	2 x 5.00	SEE MFR	SEE MFR	VELCRO USA INC.	11153
8	1	151394	VELCRO, DETAIL	LOOP 1000, BLACK, 8224 PSA	2 X 3.125	SEE MFR	SEE MFR	VELCRO USA INC.	11153
9	1	151405	VELCRO, DETAIL	HOOK 88, BLACK 8289 PSA	2 x 12.00	SEE MFR	SEE MFR	VELCRO USA INC.	11153
10	1	151405	VELCRO, DETAIL	HOOK 88, BLACK 8224 PSA	2 X 9.00	SEE MFR	SEE MFR	VELCRO USA INC.	11153
11	1	151405	VELCRO, DETAIL	HOOK 88, BLACK 8289 PSA	2 x 5.00	SEE MFR	SEE MFR	VELCRO USA INC.	11153
12	1	151405	VELCRO, DETAIL	HOOK 88, BLACK 8289 PSA	2 X 3.125	SEE MFR	SEE MFR	VELCRO USA INC.	11153
13	1	AAL-312-021-012	FWD RHS HINGED DOOR FLOOR PROTECTION, ASSY	NA	NA	NA	NA	ALPINE AEROTECH LP	L0171
14	1	AAL-312-021-002	FWD RHS HINGED DOOR FLOOR PROTECTION, ASSY	NA	NA	NA	NA	ALPINE AEROTECH LP	L0171
15	1	AAL-312-022-002	FWD RHS HINGED DOOR FLOOR PROTECTION, DETAIL	P2C /TUFFCOAT B/SIDES	0.1	SEE MFR	SEE MFR	ALPINE AEROTECH LP	L0171
16	2	151394	VELCRO, DETAIL	LOOP 1000, BLACK, 8224 PSA	2 X 15.00	SEE MFR	SEE MFR	VELCRO USA INC.	11153



ALPINE AEROTECH LP

www.alpineaerotech.com



1260 Industrial Road, Kelowna, B.C., Canada V1Z 1G5
Phone: (250) 769-6344 Fax: (250) 769-6303
admin@alpineaerotech.com

ITEM	QTY	NUMBER	DESCRIPTION	MATERIAL	REF STOCK SIZE	SPEC	FINISH	MANUFACTURER	NCAGEC
17	1	151394	VELCRO, DETAIL	LOOP 1000, BLACK, 8224 PSA	2 X 12.00	SEE MFR	SEE MFR	VELCRO USA INC.	11153
18	4	151394	VELCRO, DETAIL	LOOP 1000, BLACK, 8224 PSA	2 x 5.00	SEE MFR	SEE MFR	VELCRO USA INC.	11153
19	1	151394	VELCRO, DETAIL	LOOP 1000, BLACK, 8224 PSA	2 X 3.125	SEE MFR	SEE MFR	VELCRO USA INC.	11153
20	1	151405	VELCRO, DETAIL	HOOK 88, BLACK 8289 PSA	2 x 12.00	SEE MFR	SEE MFR	VELCRO USA INC.	11153
21	4	151405	VELCRO, DETAIL	HOOK 88, BLACK 8289 PSA	2 x 5.00	SEE MFR	SEE MFR	VELCRO USA INC.	11153
22	1	151405	VELCRO, DETAIL	HOOK 88, BLACK 8289 PSA	2 X 3.125	SEE MFR	SEE MFR	VELCRO USA INC.	11153
23	1	AAL-312-021-017	AFT HINGED DOOR FLOOR PROTECTION, ASSY	NA	NA	NA	NA	ALPINE AEROTECH LP	L0171
24	1	AAL-312-021-003	AFT HINGED DOOR FLOOR PROTECTION, ASSY	NA	NA	NA	NA	ALPINE AEROTECH LP	L0171
25	1	AAL-312-022-003	AFT HINGED DOOR FLOOR PROTECTION, DETAIL	P2C W/TUFFCOAT B/SIDES	0.1	SEE MFR	SEE MFR	ALPINE AEROTECH LP	L0171
26	4	151394	VELCRO, DETAIL	LOOP 1000, BLACK, 8224 PSA	2 X 26.00	SEE MFR	SEE MFR	VELCRO USA INC.	11153
27	1	151394	VELCRO, DETAIL	LOOP 1000, BLACK, 8224 PSA	2 X 31.066	SEE MFR	SEE MFR	VELCRO USA INC.	11153
28	2	151394	VELCRO, DETAIL	LOOP 1000, BLACK, 8224 PSA	2 X 9.00	SEE MFR	SEE MFR	VELCRO USA INC.	11153
29	2	151405	VELCRO, DETAIL	HOOK 88, BLACK 8224 PSA	2 X 9.00	SEE MFR	SEE MFR	VELCRO USA INC.	11153
30	1	151405	VELCRO, DETAIL	HOOK 88, BLACK 8289 PSA	2 X 31.066	SEE MFR	SEE MFR	VELCRO USA INC.	11153
31	1	AAL-312-022-011	DOOR SILL, DETAIL	301 1/4 HARD	0.025	AMS 5517	SEE SPEC	ALPINE AEROTECH LP	L0171
32	1	AAL-312-022-012	DOOR SILL, DETAIL	301 1/4 HARD	0.025	AMS 5517	SEE SPEC	ALPINE AEROTECH LP	L0171



ALPINE AEROTECH LP

www.alpineaerotech.com



1260 Industrial Road, Kelowna, B.C., Canada V1Z 1G5

Phone: (250) 769-6344 Fax: (250) 769-6303

admin@alpineaerotech.com

ITEM	QTY	NUMBER	DESCRIPTION	MATERIAL	REF STOCK SIZE	SPEC	FINISH	MANUFACTURER	NCAGEC
1 33	24	ISO 7046-1-M4 x 16	SCREW, MACHINE	SEE SPEC	SEE SPEC	ISO 7046-1	SEE SPEC	SOURCE AS REQUIRED	NA
2 34	4	ISO 7045-M4 x 18	PAN HEAD PHILLIPS, MACHINE SCREW	SEE SPEC	SEE SPEC	ISO 7045	SEE SPEC	SOURCE AS REQUIRED	NA
35	1	3M SAFETY-WALK SLIP-RESISTANT GENERAL PURPOSE TAPES AND TREADS 620, CLEAR 4in - 70070975621	SAFETY-WALK GENERAL PURPOSE GRIP TAPE	POLY-URETHANE	208.00"	NA	NFSI SCOF < 0.60	3M	NA